

KP04 Series

Illuminated Surface Mount Pushbuttons



Reflow Soldering Capability

General Specifications

Electrical Capacity (Resistive Load)

Low Level: 100mA maximum @ 12V DC

Other Ratings

Contact Resistance:	200 milliohms maximum
Insulation Resistance:	100 megohms minimum @ 250V DC
Dielectric Strength:	500V AC minimum between contacts for 1 minute minimum 500V AC minimum between contacts & case for 1 minute minimum
Mechanical Life:	3,000,000 operations minimum
Electrical Life:	3,000,000 operations minimum
Nominal Operating Force:	1.6N ± 0.6N
Total Travel:	.138" (3.5mm)

Materials & Finishes

Upper Plunger:	Polyacetal
Lower Plunger/Housing:	Glass fiber reinforced polyamide
Movable Contact:	Stainless steel with gold plating
Stationary Contacts:	Gold over copper alloy
Terminals:	Copper alloy with tin plating

Environmental Data

Operating Temperature Range:	-25°C through +50°C (-13°F through +122°F)
Humidity:	90 ~ 95% humidity for 240 hours @ 40°C (104°F)
Vibration:	10 ~ 55Hz with peak-to-peak amplitude of 1.5mm traversing the frequency range and returning in 1 minute; 3 right angled directions for 2 hours
Shock:	51G (500m/s ²) acceleration (tested in 6 right angled directions, with 5 shocks in each direction)

Installation

Cap Installation Force: 50.0N maximum downward force on actuator

PCB Processing

Soldering:	Reflow Soldering. Preheat temperature: 180° ~ 200°C @ 2 minutes maximum Heating temperature: 230°C @ 60 seconds maximum; Peak temperature: 250°C; Cycles: 2 Manual Soldering. 390°C @ 4 seconds maximum; Cycles: 2
Cleaning:	These devices are not process sealed. Hand clean locally using alcohol based solution.

Standards & Certifications

Flammability Standards: UL 94 HB lower housing

The KP04 Series pushbuttons have not been tested for UL recognition or CSA certification. These switches are designed for use in a low-voltage, low-current, logic-level circuit. When used as intended in a logic-level circuit, the results do not produce hazardous energy.

Applications

- Broadcasting, Audio, Video Equipment
- Automated Systems
- Communications Equipment

Distinctive Characteristics

One of the most preferred series of illuminated pushbuttons in the industry now features surface mount technology.

Surface mount technology facilitates diminished board and material handling expenses, in addition to minimized routing of traces and fewer drilled holes.

RGBP LED dispenses vibrant full color spectrum in unlimited color combinations. The RGBW with white option aids in reducing variations of the color tones for white illumination, administering stable and consistent color.

Distinct, total travel of .138" (3.5mm).

Switch actuation is synchronized with contact timing, delivering color without delay simultaneous to actuating the device. Switching ON signals safe, reliable and intuitive operation.

Choice of nontactile or tactile/audible actuation.

Compact design with height of .906" (23.0mm) from PC board to top of cap (same height as programmable SmartDisplay).

Flat, sculptured or home key square caps in three common sizes for design flexibility in diverse applications.

Twin contacts with gold plating assure high reliability and long life of 3,000,000 operations minimum.

Custom legends available.

Remarkably precise coplanarity: all considered surfaces lying between two parallel planes are a maximum distance apart of .0039" (0.1mm).

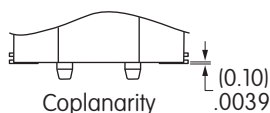
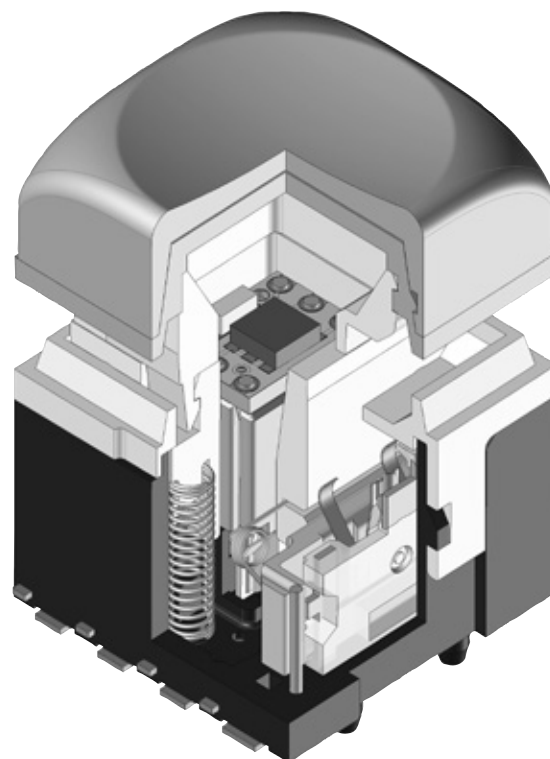

Actual Size



TYPICAL SWITCH

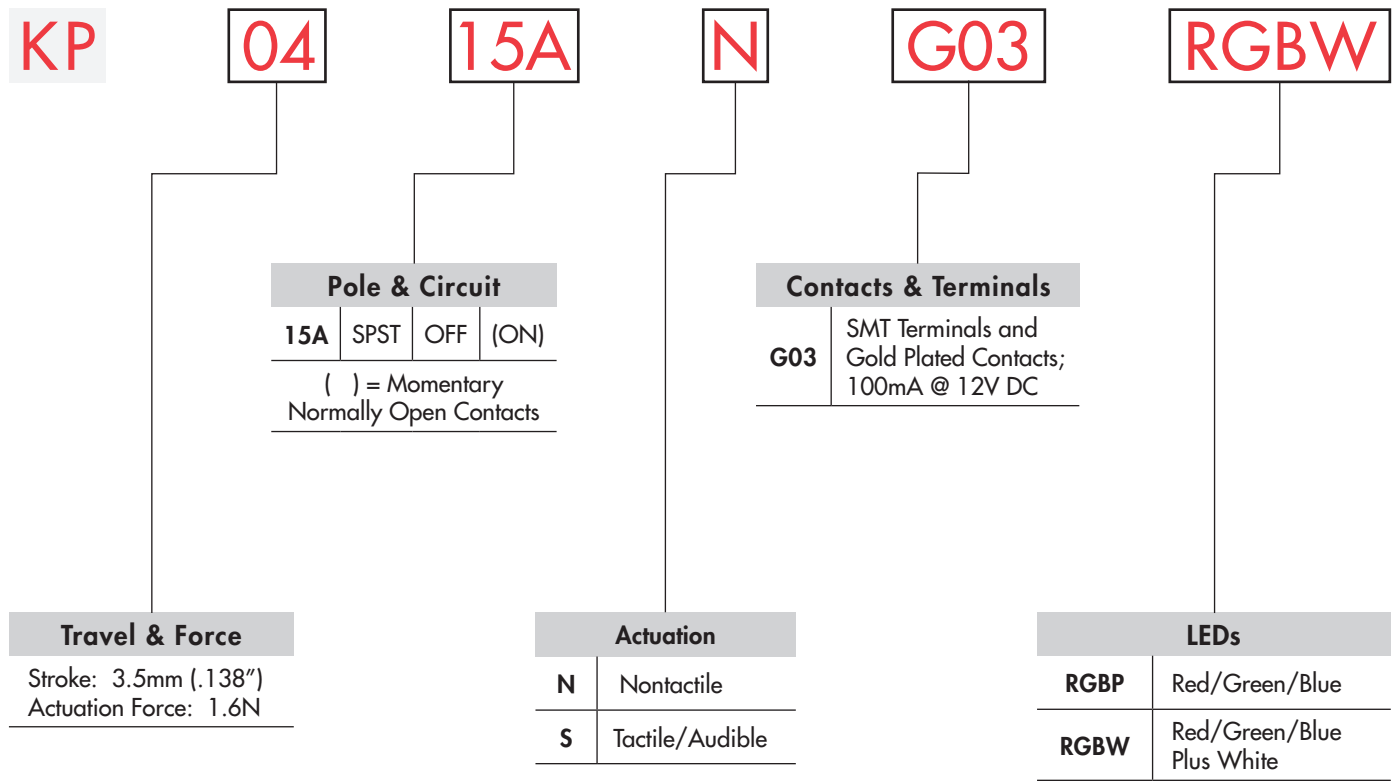

DESCRIPTION FOR TYPICAL ORDERING EXAMPLE

KP0415ANG03RGBW-2SJB

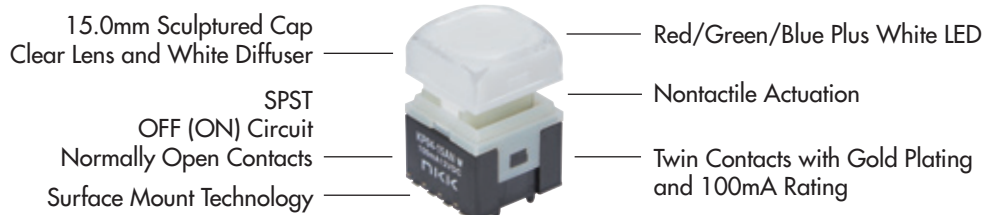

ORDERING EXAMPLE

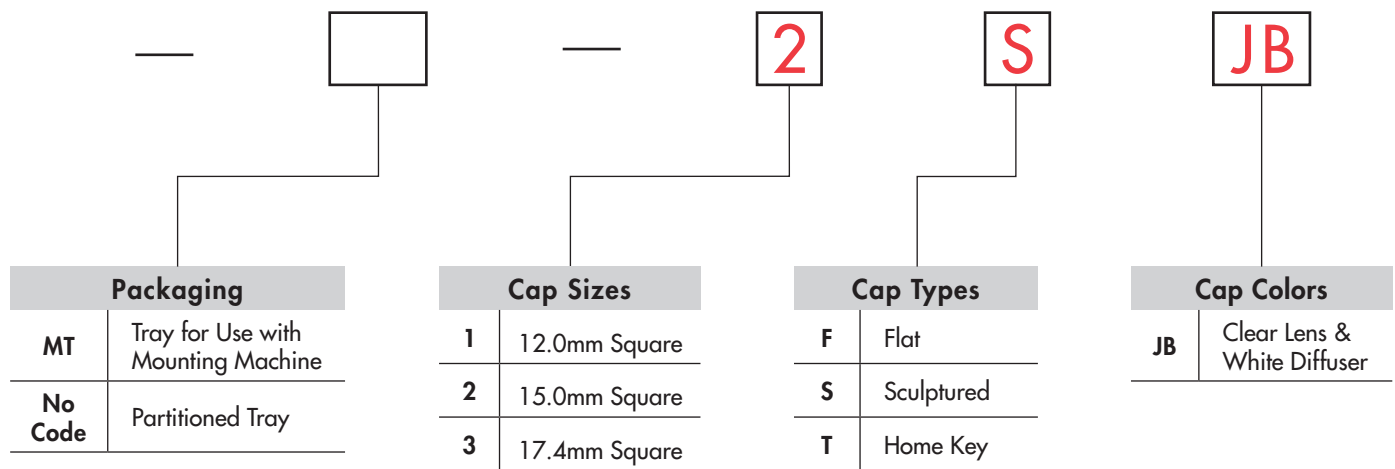





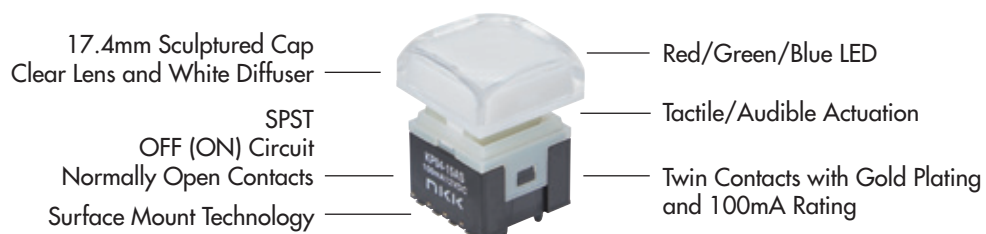



DESCRIPTION FOR TYPICAL ORDERING EXAMPLE

KP0415ASG03RGBP-3SJB



POLE & CIRCUIT

		Plunger Position () = Momentary		Connected Terminals		Throw & Switch Schematic
Pole	Model	Normal 	Down 	Normal 	Down 	Note: Switch terminal numbers are not marked on the switch.
SP	KP0415A	OFF 	(ON) 	Normally Open 	1-1a 	SPST 

ACTUATION

N Nontactile

S Tactile/Audible

CONTACTS, TERMINALS & RATING

G03 Gold Contacts

SMT Terminals

100mA @ 12V DC

LED SPECIFICATIONS



The electrical specifications shown are determined at a basic temperature of 25°C.

LEDs are an integral part of the switch and are not available separately.

The LED circuit is isolated and requires an external power source.

If the source voltage exceeds the rated voltage, a ballast resistor is required.

The resistor value can be calculated by using the formula shown below.

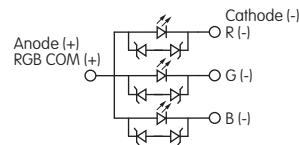

RGBP LED

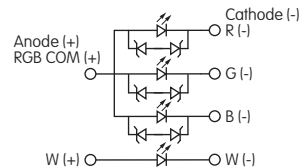

RGBW LED

Color

RGBP

Red, Green, Blue

RGBW

Red, Green, Blue, White

		Red	Green	Blue	White
Maximum Forward Current	I_{FM}	25mA	25mA	25mA	25mA
Measured Forward Current	I_F	20mA	20mA	20mA	20mA
Minimum Forward Current	I_F	5mA	5mA	5mA	1mA
* Forward Voltage	V_F	2.10V	2.65V	2.90V	3.08V
Maximum Reverse Voltage	V_{RM}	5V	5V	5V	5V
* Dominant Wavelength	λ_d	621nm	530nm	465nm	—
Ambient Temperature Range		-25 ~ +50			

* Forward Voltage (V_F) and Dominant Wavelength (λ_d) are Typical Value determined by Measured Forward Current (I_F).

For best results and safe use of LEDs, the supply voltage should be more than the LED forward voltage. Also, an appropriately valued ballast resistor should be used. Without the ballast resistor, the LED will be damaged or destroyed. The resistor value can be calculated by using the formula shown here.

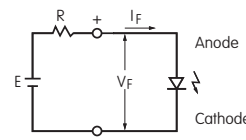

$$R = \frac{E - V_F}{I_F}$$

Where: R = Resistor Value (Ohms)
E = Source Voltage (V)
 V_F = Forward Voltage (V)
 I_F = Forward Current (A)

CAP TYPES & COLORS

Caps for Nontactile & Tactile/Audible

1 12.0mm Square

F AT3183 Flat Cap

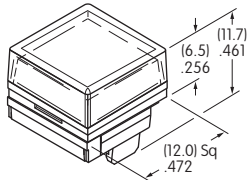

S AT3178 Sculptured Cap

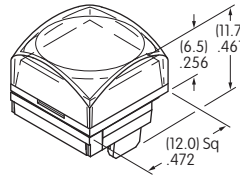

T AT3186 Home Key Cap

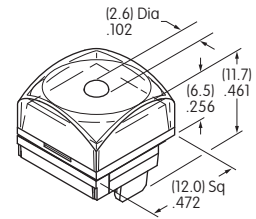

2 15.0mm Square

F AT3184 Flat Cap

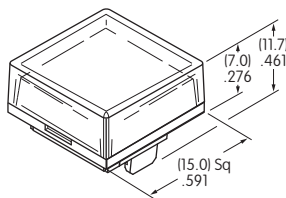

S AT3179 Sculptured Cap

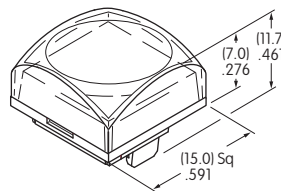

T AT3187 Home Key Cap

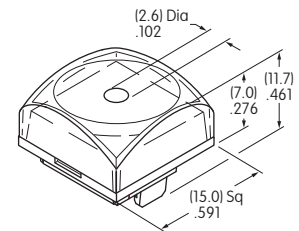

3 17.4mm Square

F AT3185 Flat Cap

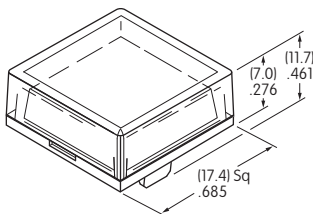

S AT3181 Sculptured Cap

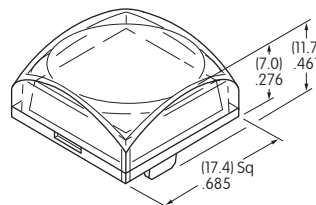

T AT3188 Home Key Cap

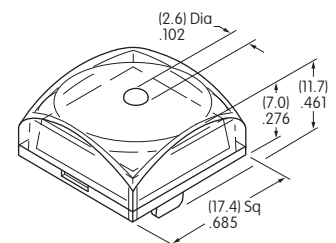

JB Lens & Diffuser Colors Available:

Clear/White

Materials & Finishes: Lens - Polycarbonate with glossy finish

Diffuser - Polycarbonate with textured finish

Upper Plunger - Polyacetal

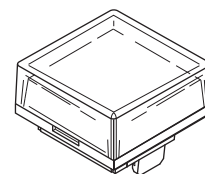

Clear Lens

White Diffuser
(Not Removable)

Optional Protective Guard AT4170 available for use with 15mm caps
(codes 2F (AT3184), 2S (AT3179) or 2T (AT3187))

TYPICAL SWITCH DIMENSIONS

12.0mm Square Cap • Nontactile • RGBW LED

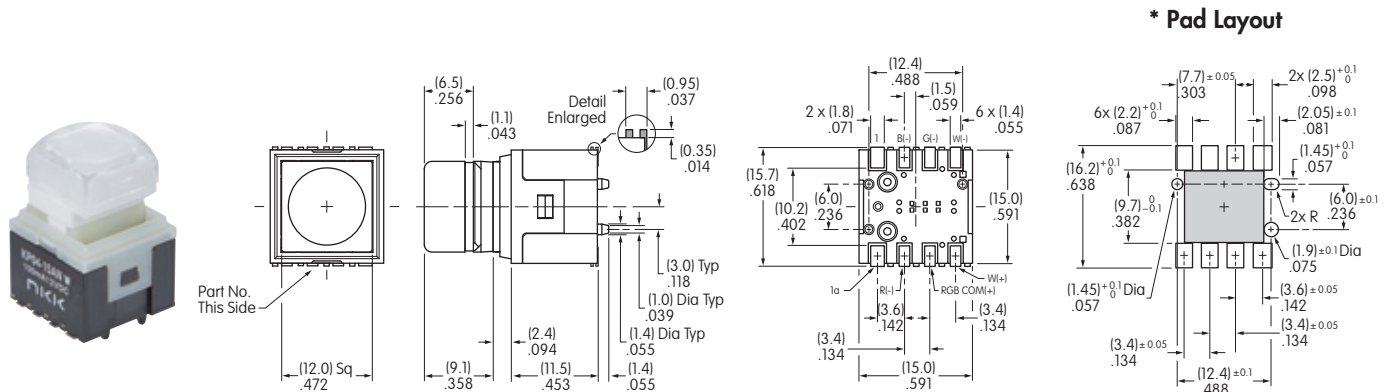

KP0415ANG03RGBW-1SJB

15.0mm Square Cap • Nontactile • RGBW LED

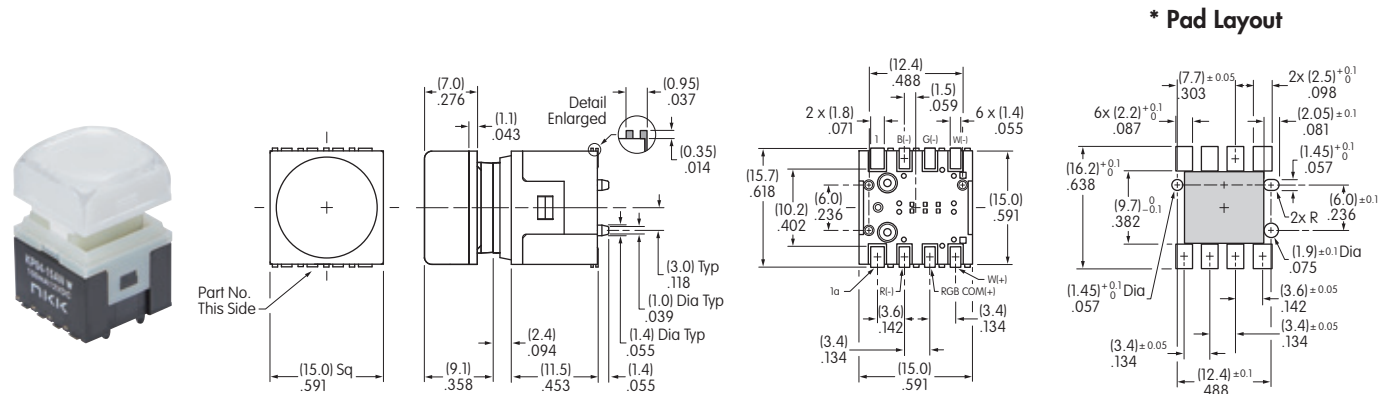

KP0415ANG03RGBW-2SJB

17.4mm Square Cap • Nontactile • RGBP LED

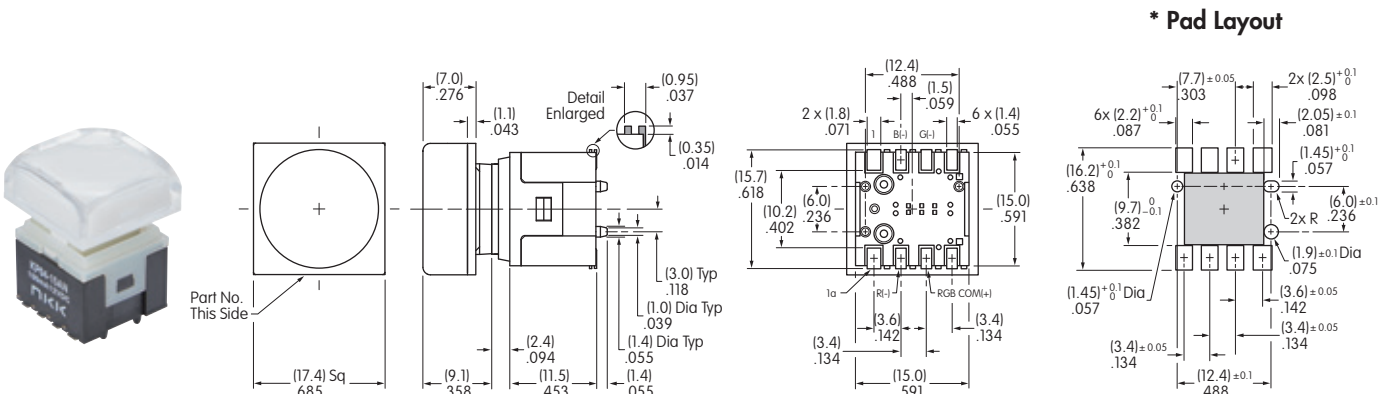

KP0415ANG03RGBP-3SJB

* Note: Gray area of Pad Layout may come in contact with metal parts on bottom of switch. Consider when designing PC board.

TYPICAL SWITCH DIMENSIONS

12.0mm Square Cap • Tactile/Audible • RGBW LED

* Pad Layout

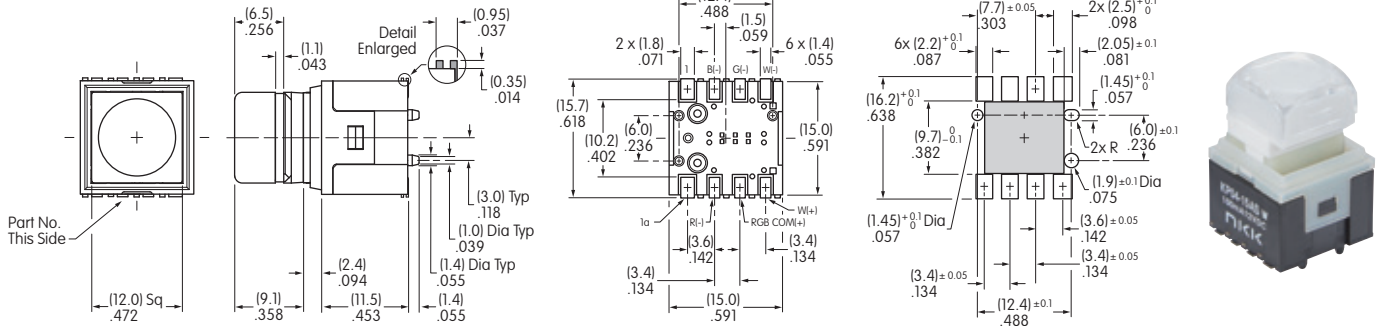

KP0415ASG03RGBW-1SJB

15.0mm Square Cap • Tactile/Audible • RGBW LED

* Pad Layout

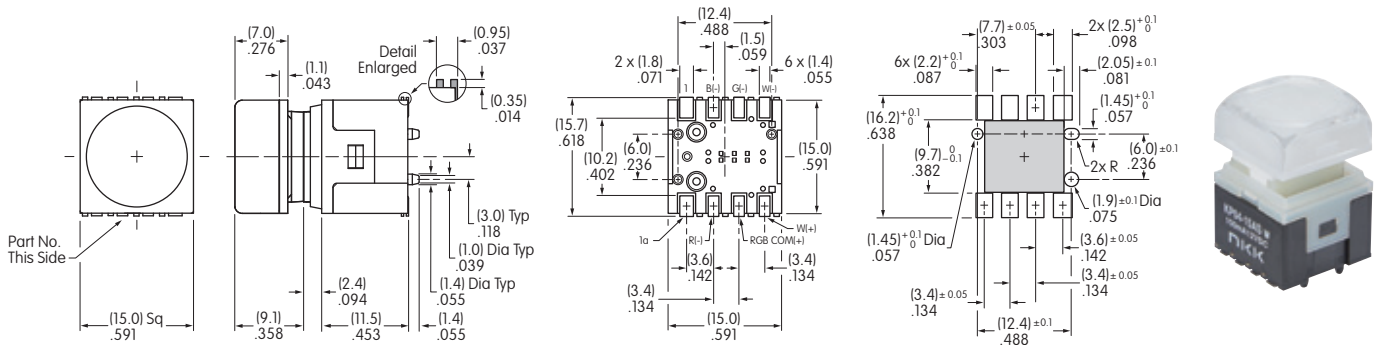

KP0415ASG03RGBW-2SJB

17.4mm Square Cap • Tactile/Audible • RGBP LED

* Pad Layout

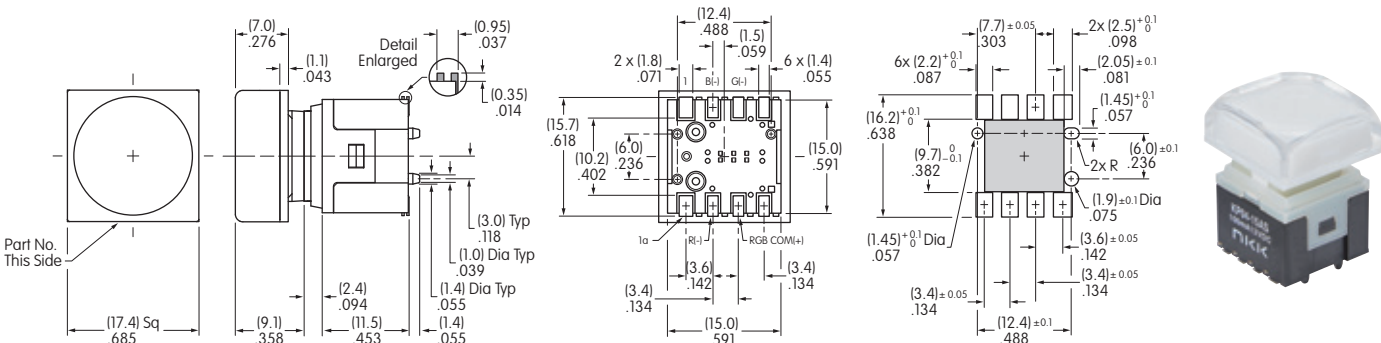

KP0415ASG03RGBP-3SJB

* Note: Gray area of Pad Layout may come in contact with metal parts on bottom of switch. Consider when designing PC board.

PACKAGING

MT

Partitioned Tray Packaging for Mounting Machine

96 pieces per tray

Switches must be ordered in 96-piece increments when tray packaging for Mounting Machines is selected.

Series KP04 is compatible with most automatic mounting machines. Confirm the type of mounting machine required in advance.

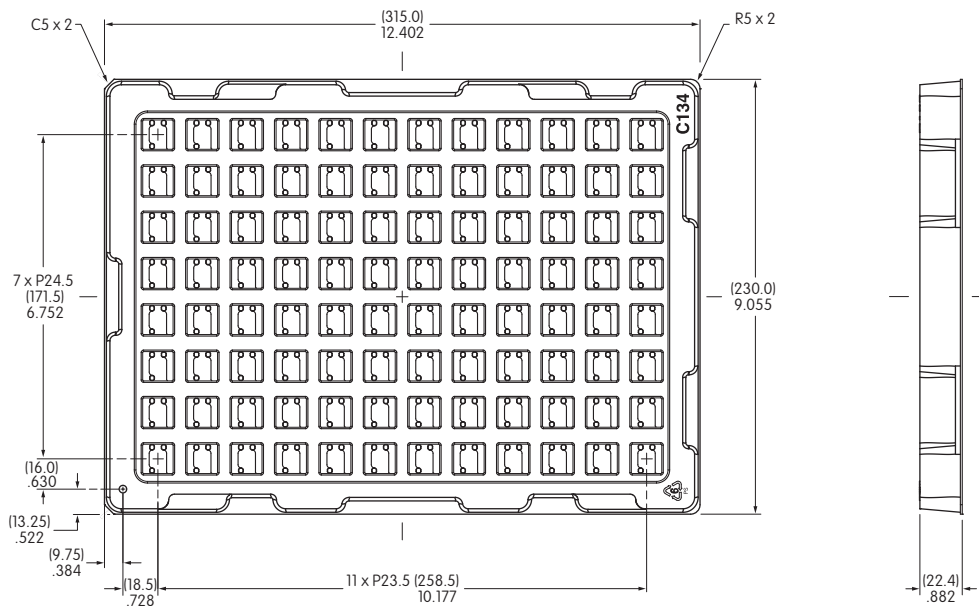

When transporting, handle only the outer perimeter of the tray.
Any external force may damage the switches and tray, resulting in malfunction or mounting defects.

No Code

Partitioned Tray Packaging

Any quantity fewer than 96 pieces

When switches are ordered in less than 96-piece increments, they are packaged in a partitioned tray.
No code is required.

SAFETY PRECAUTIONS & INSTALLATION INSTRUCTIONS

Soldering

Manual Soldering

Manual Solder Profile	Profile A High Temperature
Solder Iron Tip Temperature	390°C Maximum
Time on Terminal	4 Seconds Maximum
Cycles	2

- Profiles are for lead-free components.
- Use an alcohol based solution for flux cleaning on the PC board surface after soldering. Series KP04 switches are not process sealed.

Reflow Soldering

Reflow Solder Profile

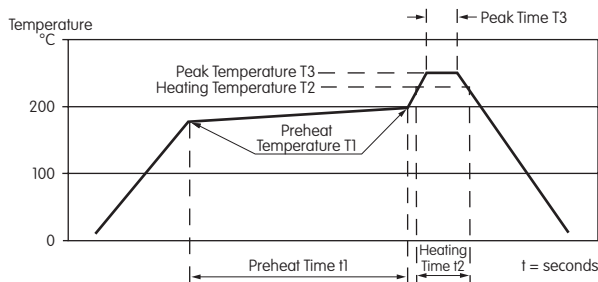

- Reflow soldering cannot be executed with the cap attached.
- The Reflow Solder Profile describes the printed circuit board (PCB) surface temperature. Since the PCB surface temperature and the switch surface temperature will vary depending on the height of the switch, the PCB material, and PCB thickness, ensure that the switch surface temperature does not exceed 250°C for high temperature.
- Verify soldering conditions prior to beginning the process.

Reflow Solder Profile	Symbol	Profile A High Temperature
Preheat Temperature	T1	180°C ~ 200°C
Preheat Time	t1	120 Seconds Maximum
Heating Temperature	T2	230°C Minimum
Heating Time	t2	60 Seconds Maximum
Peak Temperature (Surface)	T3	250°C Maximum
Peak Time	t3	Not Specified
Thickness of PCB		1.6mm
Cycles		2
Comments		PCB with No Lead

- The number of soldering procedures should not exceed two, including resoldering work, such as manual soldering.
- After soldering, ensure no mechanical stress is applied to the terminals due to bending or warping of the PC board.

Handling



Series KP04 devices are electrostatic sensitive. To avoid damage to the switches, do not touch terminals

unless properly isolated from static electricity.

Applying a reverse voltage to the LED may cause leakage current or deterioration. Depending on circuit condition, a circuit protector may be necessary.

Simultaneous Illumination

Simultaneous illumination may cause color variability due to characteristics of the LEDs. Check and adjust the current value for each color that is used. If simultaneous illumination is required with a Red/Green/Blue/White (RGBW) LED, consult with our Engineering Department.

Home Key Caps

When using the 12mm, 15mm or 17.4mm home key caps, do not apply pressure with a hard object to the projected dot on top of the caps. It may damage or deform the cap.

Legends for Top of Caps

Surfaces of the caps are ideal for legends, and recommended methods include laser etch, screen print or pad print. Before using a film insert in the actuator, contact NKK Switches. The diffuser cannot be removed.

Attaching the Cap to the Switch

Caps are not assembled to the switch until after the reflow soldering process. If reflow soldering is executed with the cap attached, LED lighting failure, damage or malfunction may occur. Remove the heat resistant film from the switch before attaching the cap.

The cap assembly is designed with projections that align with grooves on top of the switch. Confirm the recessed side of the upper plunger in the cap assembly is oriented with the recessed side of the lower plunger on top of switch and snap together. Press cap several times, checking for smooth actuation.

Operating the switch without an actuator or with actuator improperly mounted may cause a malfunction or impairment.

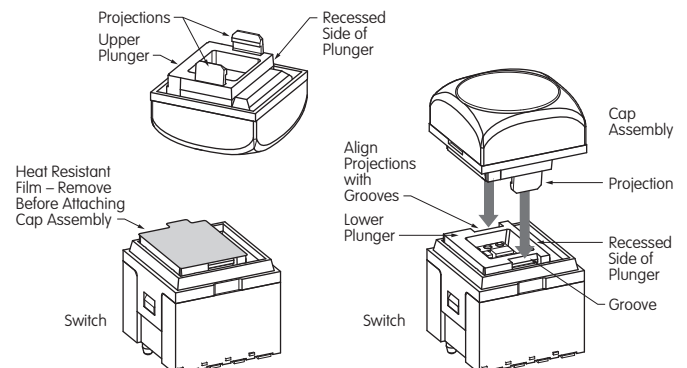

LEGENDS

NKK Switches can provide custom legends for caps. Contact factory for more information.

Suggested Printable Areas for KP04 Lens

Recommended Methods:

Laser Etch on clear lens, Screen Print or Pad Print on lens.

The Diffuser cannot be removed.

Epoxy based ink is recommended.

The Lens is the most suitable printing surface.

Shaded areas are suggested printable areas for Lens.

Flat Cap Lens

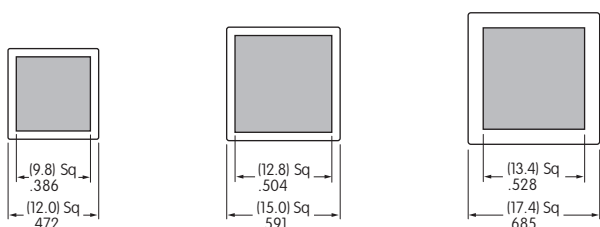

Sculptured Cap Lens

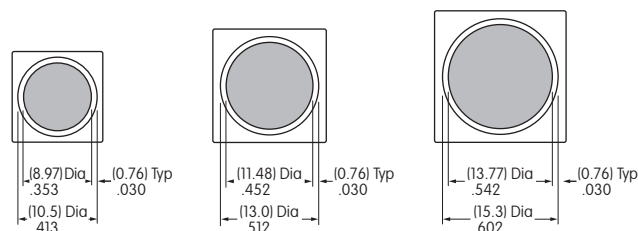

Suggested Printable Areas for KP04 Film Insert

Shaded areas are suggested printable areas for Film Insert.

If a film insert is preferred to display the legend, contact NKK Switches for more information.

Flat Cap Film Inserts

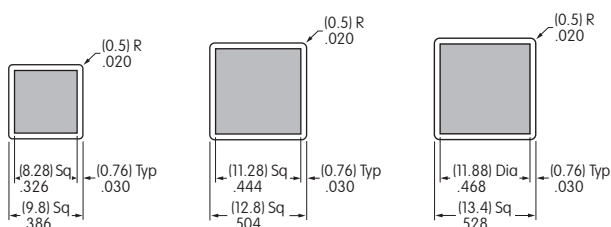

Sculptured or Home Key Cap Film Inserts

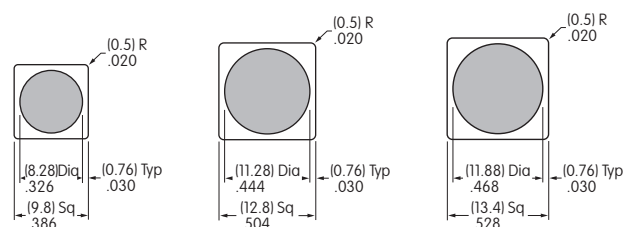

Film Insert Material and Thickness: Clear Polyester; 4 mil (100μ) maximum thickness

Effective Date March 2022



www.nkkswitches.com • 1.877.2BUYNKK (228.9655)

7850 East Gelding Drive • Scottsdale, AZ 85260 • Telephone 480.991.0942 • Fax 480.998.1435