

# MAC212A8, MAC212A10

Preferred Device

## Triacs

### Silicon Bidirectional Thyristors

Designed primarily for full-wave ac control applications, such as light dimmers, motor controls, heating controls and power supplies; or wherever full-wave silicon gate controlled solid-state devices are needed. Triac type thyristors switch from a blocking to a conducting state for either polarity of applied anode voltage with positive or negative gate triggering.

#### Features

- Blocking Voltage to 800 Volts
- All Diffused and Glass Passivated Junctions for Greater Parameter Uniformity and Stability
- Small, Rugged, Thermowatt Construction for Low Thermal Resistance, High Heat Dissipation and Durability
- Gate Triggering Guaranteed in Four Modes
- Pb-Free Packages are Available\*

#### MAXIMUM RATINGS (T<sub>J</sub> = 25°C unless otherwise noted)

| Rating   | Symbol                                 | Value       | Unit             |
|--|--|-------------|------------------|
| Peak Repetitive Off-State Voltage (Note 1)<br>(T <sub>J</sub> = -40 to +125°C, Sine Wave 50 to 60 Hz,<br>Gate Open)<br>MAC212A8<br>MAC212A10 | V <sub>DRM</sub> ,<br>V <sub>RRM</sub> | 600<br>800  | V                |
| On-State RMS Current (T <sub>C</sub> = +85°C)<br>Full Cycle Sine Wave 50 to 60 Hz  | I <sub>T(RMS)</sub>                    | 12          | A                |
| Peak Non-repetitive Surge Current (One<br>Full Cycle Sine Wave, 60 Hz, T <sub>C</sub> = +25°C)<br>Preceded and followed by rated current     | I <sub>TSM</sub>                       | 100         | A                |
| Circuit Fusing Considerations (t = 8.3 ms)   | I <sup>2</sup> t                       | 40          | A <sup>2</sup> s |
| Peak Gate Power<br>(T <sub>C</sub> = +85°C, Pulse Width = 10 μs)   | P <sub>GM</sub>                        | 20          | W                |
| Average Gate Power<br>(T <sub>C</sub> = +85°C, t = 8.3 ms)   | P <sub>G(AV)</sub>                     | 0.35        | W                |
| Peak Gate Current<br>(T <sub>C</sub> = +85°C, Pulse Width = 10 μs)   | I <sub>GM</sub>                        | 2.0         | A                |
| Operating Junction Temperature Range   | T <sub>J</sub>                         | -40 to +125 | °C               |
| Storage Temperature Range  | T <sub>stg</sub>                       | -40 to +150 | °C               |

Maximum ratings are those values beyond which device damage can occur. Maximum ratings applied to the device are individual stress limit values (not normal operating conditions) and are not valid simultaneously. If these limits are exceeded, device functional operation is not implied, damage may occur and reliability may be affected.

1. V<sub>DRM</sub> and V<sub>RRM</sub> for all types can be applied on a continuous basis. Blocking voltages shall not be tested with a constant current source such that the voltage ratings of the devices are exceeded.

\*For additional information on our Pb-Free strategy and soldering details, please download the ON Semiconductor Soldering and Mounting Techniques Reference Manual, SOLDERRM/D.



ON Semiconductor®

<http://onsemi.com>

**TRIACS**  
**12 AMPERES RMS**  
**600 thru 800 VOLTS**

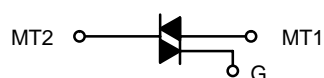

#### MARKING DIAGRAM

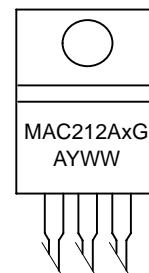
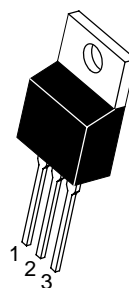

**TO-220AB**  
**CASE 221A-07**  
**STYLE 4**

- x = 8 or 10
- A = Assembly Location
- Y = Year
- WW = Work Week
- G = Pb-Free Package

#### PIN ASSIGNMENT

| Pin | Assignment      |
|-----|-----------------|
| 1   | Main Terminal 1 |
| 2   | Main Terminal 2 |
| 3   | Gate            |
| 4   | Main Terminal 2 |

#### ORDERING INFORMATION

| Device     | Package               | Shipping        |
|------------|-----------------------|-----------------|
| MAC212A8D  | TO-220AB              | 500 Units / Box |
| MAC212A8DG | TO-220AB<br>(Pb-Free) | 500 Units / Box |
| MAC212A10  | TO-220AB              | 500 Units / Box |
| MAC212A10G | TO-220AB<br>(Pb-Free) | 500 Units / Box |

Preferred devices are recommended choices for future use and best overall value.

# MAC212A8, MAC212A10

## THERMAL CHARACTERISTICS

| Characteristic   | Symbol          | Value | Unit                        |
|--|-----------------|-------|-----------------------------|
| Thermal Resistance, Junction-to-Case                                       | $R_{\theta JC}$ | 2.0   | $^{\circ}\text{C}/\text{W}$ |
| Junction-to-Ambient  | $R_{\theta JA}$ | 62.5  |                             |
| Maximum Lead Temperature for Soldering Purposes 1/8" from Case for 10 Secs | $T_L$           | 260   | $^{\circ}\text{C}$          |

## ELECTRICAL CHARACTERISTICS ( $T_C = 25^{\circ}\text{C}$ unless otherwise noted; Electricals apply in both directions)

| Characteristic | Symbol | Min | Typ | Max | Unit |
|----------------|--------|-----|-----|-----|------|
|----------------|--------|-----|-----|-----|------|

### OFF CHARACTERISTICS

|  |                          |   |   |     |               |
|--|--------------------------|---|---|-----|---------------|
| Peak Repetitive Blocking Current<br>( $V_D = \text{Rated } V_{DRM}$ , $V_{RRM}$ ; Gate Open) | $I_{DRM}$ ,<br>$I_{RRM}$ | - | - | 10  | $\mu\text{A}$ |
| $T_J = 25^{\circ}\text{C}$   |                          |   |   |     |               |
| $T_J = +125^{\circ}\text{C}$   |                          |   |   | 2.0 | $\text{mA}$   |

### ON CHARACTERISTICS

|  |          |     |     |      |               |
|--|----------|-----|-----|------|---------------|
| Peak On-State Voltage<br>$I_{TM} = \pm 17 \text{ A Peak}$ ; Pulse Width = 1 to 2 ms, Duty Cycle $\leq 2\%$   | $V_{TM}$ | -   | 1.3 | 1.75 | V             |
| Gate Trigger Current (Continuous dc)<br>(Main Terminal Voltage = 12 Vdc, $R_L = 100 \Omega$ )  | $I_{GT}$ | -   | 12  | 50   | $\text{mA}$   |
| MT2(+), G(+)   | -        | 12  | 50  |      |               |
| MT2(+), G(-)   | -        | 20  | 50  |      |               |
| MT2(-), G(-)   | -        | 35  | 75  |      |               |
| MT2(-), G(+)   | -        |     |     |      |               |
| Gate Trigger Voltage (Continuous dc)<br>(Main Terminal Voltage = 12 Vdc, $R_L = 100 \Omega$ )  | $V_{GT}$ | -   | 0.9 | 2.0  | V             |
| MT2(+), G(+)   | -        | 0.9 | 2.0 |      |               |
| MT2(+), G(-)   | -        | 1.1 | 2.0 |      |               |
| MT2(-), G(-)   | -        | 1.4 | 2.5 |      |               |
| MT2(-), G(+)   | -        |     |     |      |               |
| Gate Non-Trigger Voltage (Continuous dc)<br>(Main Terminal Voltage = 12 V, $R_L = 100 \Omega$ , $T_J = +125^{\circ}\text{C}$ )<br>All Four Quadrants                       | $V_{GD}$ | 0.2 | -   | -    | V             |
| Holding Current<br>(Main Terminal Voltage = 12 Vdc, Gate Open,<br>Initiating Current = $\pm 200 \text{ mA}$ )  | $I_H$    | -   | 6.0 | 50   | $\text{mA}$   |
| Turn-On Time<br>( $V_D = \text{Rated } V_{DRM}$ , $I_{TM} = 17 \text{ A}$ , $I_{GT} = 120 \text{ mA}$ ,<br>Rise Time = $0.1 \mu\text{s}$ , Pulse Width = $2 \mu\text{s}$ ) | $t_{gt}$ | -   | 1.5 | -    | $\mu\text{s}$ |

### DYNAMIC CHARACTERISTICS

|   |               |   |     |   |                        |
|---|---------------|---|-----|---|------------------------|
| Critical Rate of Rise of Commutation Voltage<br>( $V_D = \text{Rated } V_{DRM}$ , $I_{TM} = 17 \text{ A}$ , Commutating $di/dt = 6.1 \text{ A/ms}$ ,<br>Gate Unenergized, $T_C = +85^{\circ}\text{C}$ ) | $dv/dt_{(c)}$ | - | 5.0 | - | $\text{V}/\mu\text{s}$ |
| Critical Rate of Rise of Off-State Voltage<br>( $V_D = \text{Rated } V_{DRM}$ , Exponential Voltage Rise, Gate Open, $T_C = +85^{\circ}\text{C}$ )  | $dv/dt$       | - | 100 | - | $\text{V}/\mu\text{s}$ |

# MAC212A8, MAC212A10

## Voltage Current Characteristic of Triacs (Bidirectional Device)

| Symbol    | Parameter                                 |
|-----------|---|
| $V_{DRM}$ | Peak Repetitive Forward Off State Voltage |
| $I_{DRM}$ | Peak Forward Blocking Current             |
| $V_{RRM}$ | Peak Repetitive Reverse Off State Voltage |
| $I_{RRM}$ | Peak Reverse Blocking Current             |
| $V_{TM}$  | Maximum On State Voltage                  |
| $I_H$     | Holding Current                           |

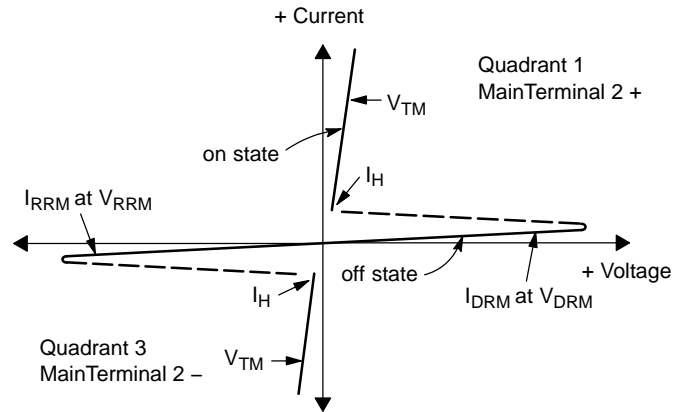

### Quadrant Definitions for a Triac

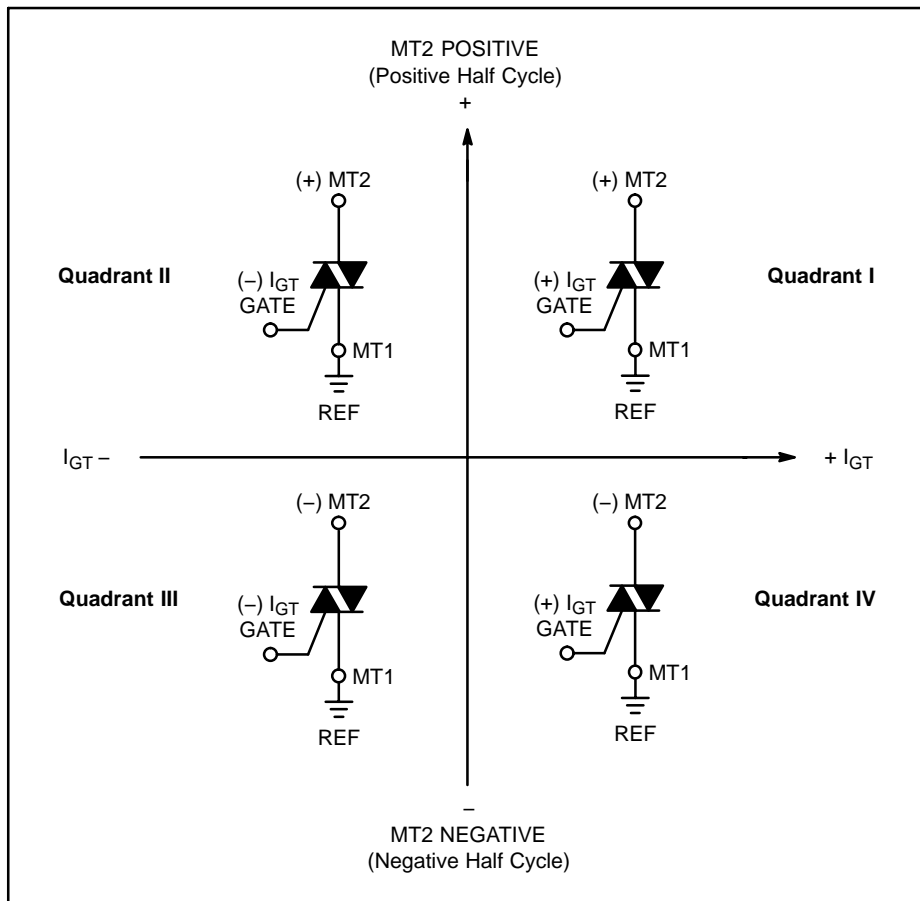

All polarities are referenced to MT1.  
With in-phase signals (using standard AC lines) quadrants I and III are used.

# MAC212A8, MAC212A10

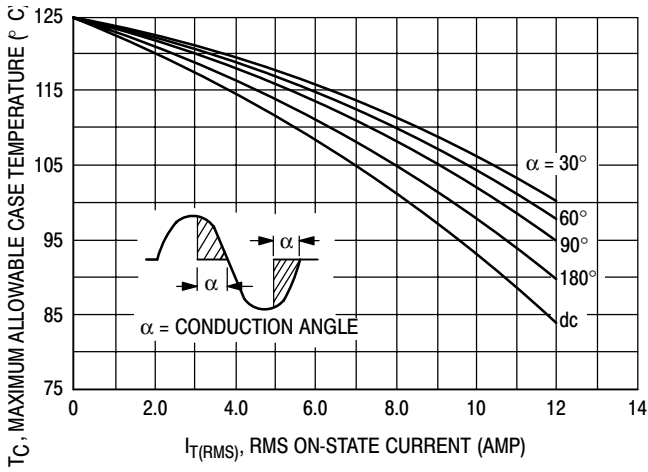

Figure 1. Current Derating

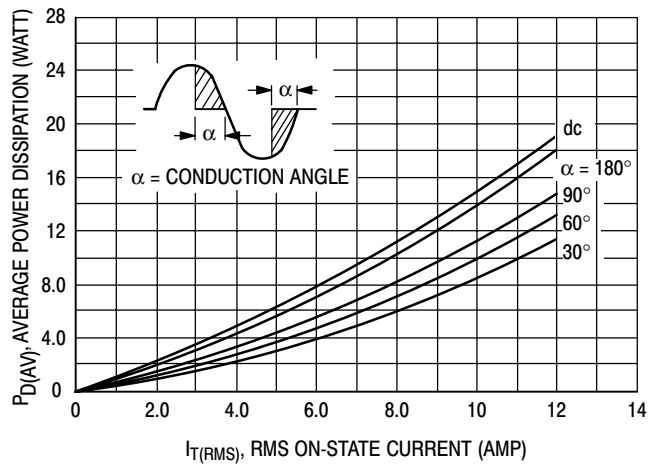

Figure 2. Power Dissipation

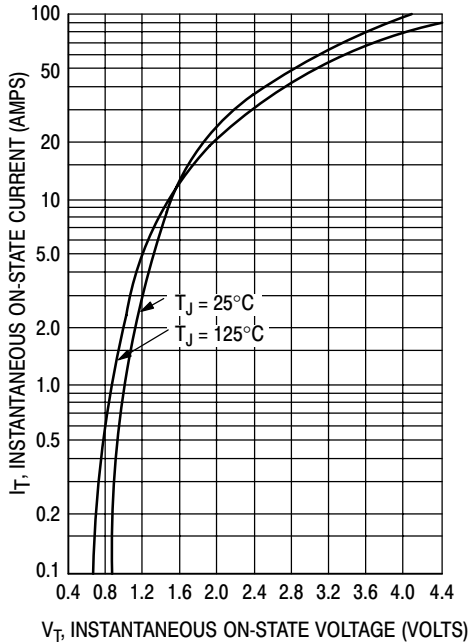

Figure 3. Maximum On-State Voltage Characteristics

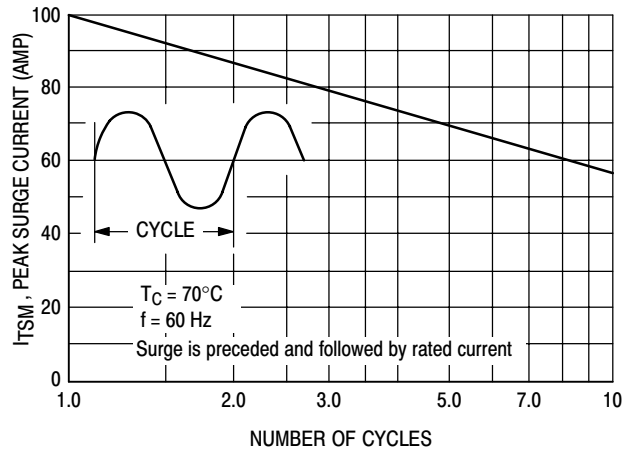

Figure 4. Maximum Non-Repetitive Surge Current

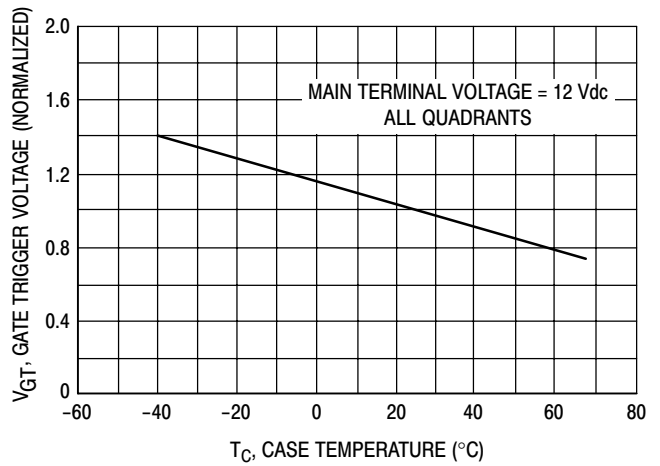

Figure 5. Typical Gate Trigger Voltage

# MAC212A8, MAC212A10

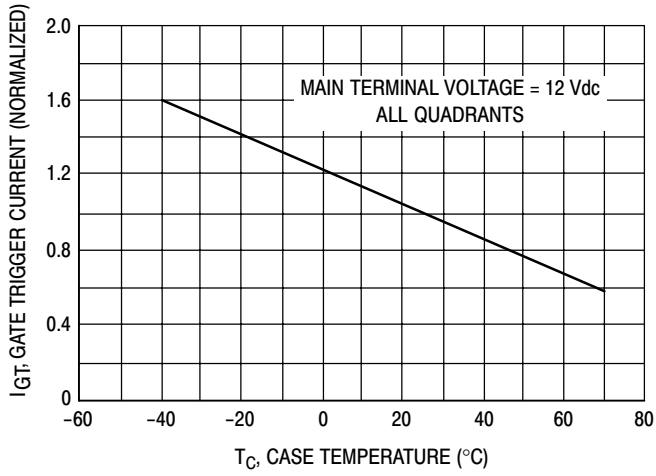

Figure 6. Typical Gate Trigger Current

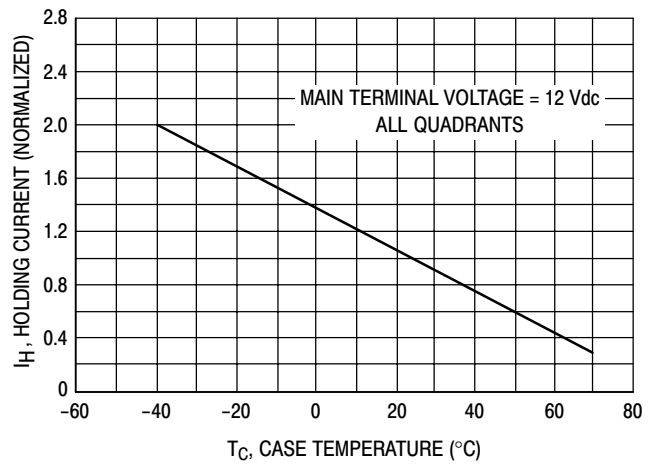

Figure 7. Typical Holding Current

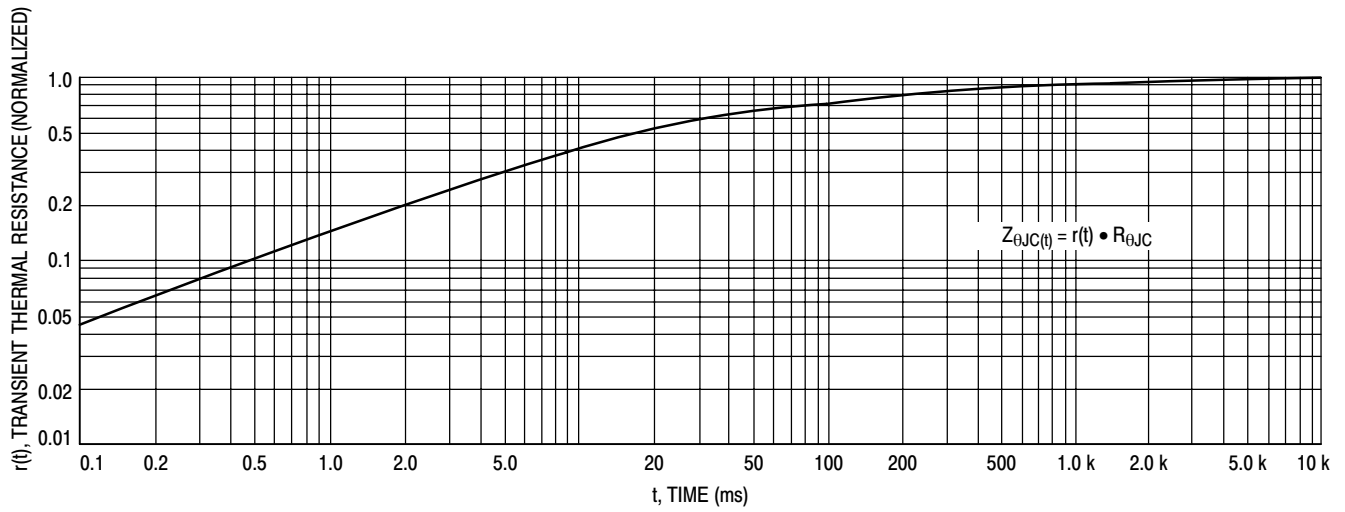
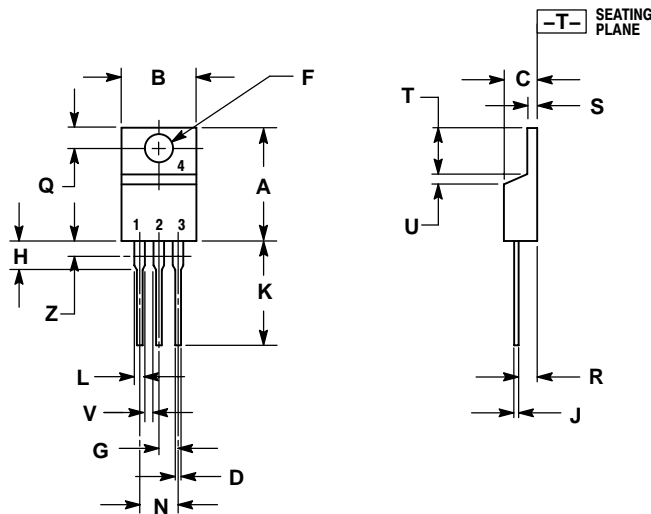

Figure 8. Thermal Response

# MAC212A8, MAC212A10

## PACKAGE DIMENSIONS

TO-220AB  
CASE 221A-07  
ISSUE AA



- NOTES:
1. DIMENSIONING AND TOLERANCING PER ANSI Y14.5M, 1982.
  2. CONTROLLING DIMENSION: INCH.
  3. DIMENSION Z DEFINES A ZONE WHERE ALL BODY AND LEAD IRREGULARITIES ARE ALLOWED.

| DIM | INCHES |       | MILLIMETERS |       |
|-----|--------|-------|-------------|-------|
|     | MIN    | MAX   | MIN         | MAX   |
| A   | 0.570  | 0.620 | 14.48       | 15.75 |
| B   | 0.380  | 0.405 | 9.66        | 10.28 |
| C   | 0.160  | 0.190 | 4.07        | 4.82  |
| D   | 0.025  | 0.035 | 0.64        | 0.88  |
| F   | 0.142  | 0.147 | 3.61        | 3.73  |
| G   | 0.095  | 0.105 | 2.42        | 2.66  |
| H   | 0.110  | 0.155 | 2.80        | 3.93  |
| J   | 0.014  | 0.022 | 0.36        | 0.55  |
| K   | 0.500  | 0.562 | 12.70       | 14.27 |
| L   | 0.045  | 0.060 | 1.15        | 1.52  |
| N   | 0.190  | 0.210 | 4.83        | 5.33  |
| Q   | 0.100  | 0.120 | 2.54        | 3.04  |
| R   | 0.080  | 0.110 | 2.04        | 2.79  |
| S   | 0.045  | 0.055 | 1.15        | 1.39  |
| T   | 0.235  | 0.255 | 5.97        | 6.47  |
| U   | 0.000  | 0.050 | 0.00        | 1.27  |
| V   | 0.045  | ---   | 1.15        | ---   |
| Z   | ---    | 0.080 | ---         | 2.04  |

- STYLE 4:  
PIN 1. MAIN TERMINAL 1  
2. MAIN TERMINAL 2  
3. GATE  
4. MAIN TERMINAL 2

ON Semiconductor and are registered trademarks of Semiconductor Components Industries, LLC (SCILLC). SCILLC reserves the right to make changes without further notice to any products herein. SCILLC makes no warranty, representation or guarantee regarding the suitability of its products for any particular purpose, nor does SCILLC assume any liability arising out of the application or use of any product or circuit, and specifically disclaims any and all liability, including without limitation special, consequential or incidental damages. "Typical" parameters which may be provided in SCILLC data sheets and/or specifications can and do vary in different applications and actual performance may vary over time. All operating parameters, including "Typicals" must be validated for each customer application by customer's technical experts. SCILLC does not convey any license under its patent rights nor the rights of others. SCILLC products are not designed, intended, or authorized for use as components in systems intended for surgical implant into the body, or other applications intended to support or sustain life, or for any other application in which the failure of the SCILLC product could create a situation where personal injury or death may occur. Should Buyer purchase or use SCILLC products for any such unintended or unauthorized application, Buyer shall indemnify and hold SCILLC and its officers, employees, subsidiaries, affiliates, and distributors harmless against all claims, costs, damages, and expenses, and reasonable attorney fees arising out of, directly or indirectly, any claim of personal injury or death associated with such unintended or unauthorized use, even if such claim alleges that SCILLC was negligent regarding the design or manufacture of the part. SCILLC is an Equal Opportunity/Affirmative Action Employer. This literature is subject to all applicable copyright laws and is not for resale in any manner.

### PUBLICATION ORDERING INFORMATION

**LITERATURE FULFILLMENT:**  
Literature Distribution Center for ON Semiconductor  
P.O. Box 61312, Phoenix, Arizona 85082-1312 USA  
**Phone:** 480-829-7710 or 800-344-3860 Toll Free USA/Canada  
**Fax:** 480-829-7709 or 800-344-3867 Toll Free USA/Canada  
**Email:** orderlit@onsemi.com

**N. American Technical Support:** 800-282-9855 Toll Free  
USA/Canada

**Japan:** ON Semiconductor, Japan Customer Focus Center  
2-9-1 Kamimeguro, Meguro-ku, Tokyo, Japan 153-0051  
**Phone:** 81-3-5773-3850

**ON Semiconductor Website:** <http://onsemi.com>

**Order Literature:** <http://www.onsemi.com/litorder>

For additional information, please contact your local Sales Representative.