

COOL POWER TECHNOLOGIES

Sixteenth-Brick Isolated DC/DC Converter

Features

- Wide input voltage range: 36 – 75V_{in}
- Output: 2.5V at 20A, 50W max.
- High Efficiency – 90% typical
- RoHS 3 Directive 2015/863/EU
- No minimum load/capacitance required
- Low height - 0.374" (9.5mm) max.
- 2250V Isolation
- Withstands 100 V input transients
- Fixed-frequency operation
- Industry standard 1/16th brick footprint
- Full protection (OTP, OCP, OVP, UVLO – auto-restart)
- Remote ON/OFF - positive or negative enable logic options
- Remote sense
- Output voltage trim range: +10%/-20% (industry-standard trim equations)
- Weight: 0.44 oz (12.5 g) open frame, 0.72 oz (20.5 g) baseplate model
- On-board input differential LC-filter
- Meets UL94, V-0 flammability rating
- Compliant to REACH (EC) No 1907/2006, 205 SVHC update
- UL/CSA 60950-1 recognized, TUV certified per EN60950-1, 2nd edition
- Designed to meet Class B conducted emissions per FCC and EN55032 when used with external filter (see EMC Compliance section below.)

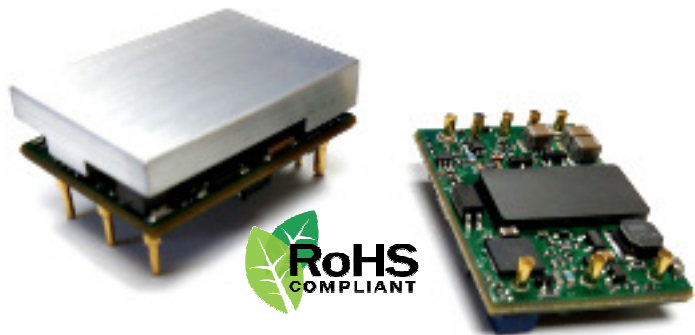

Description

The CPT20G48 “Cool Power Technologies” DC-DC converter is an open frame sixteenth-brick DC-DC converter that conforms to industry standard specifications (DOSA). The converter operates over an input voltage range of 36 to 75 VDC, and provides a tightly regulated output voltage with an output current rating of 20 A. The output is fully isolated from the input and the converter meets Basic Insulation requirements. The standard feature set includes remote On/Off (positive or negative enable), input undervoltage lockout, output overvoltage protection, overcurrent and short circuit protections, output voltage trim, remote sense and overtemperature shutdown with hysteresis. The high efficiency of the CPT20G48 allows operation over a wide ambient temperature range with minimal derating (see Characteristic Curves section below.)

TABLE OF CONTENTS

SECTION	PAGE
FEATURES & DESCRIPTION	1
APPLICATION DIAGRAM	2
ELECTRICAL SPECIFICATIONS	3
CHARACTERISTIC PERFORMANCE CURVES	6
CHARACTERISTIC WAVEFORMS	7
APPLICATION NOTES	8
• RIPPLE MEASUREMENTS TEST SET-UP	8
• OUTPUT VOLTAGE TRIM EQUATIONS	9
• THERMAL DERATING	10
• EMC COMPLIANCE	12
MECHANICAL OUTLINE & PCB FOOTPRINT	13
ORDERING INFORMATION	15

APPLICATION DIAGRAM

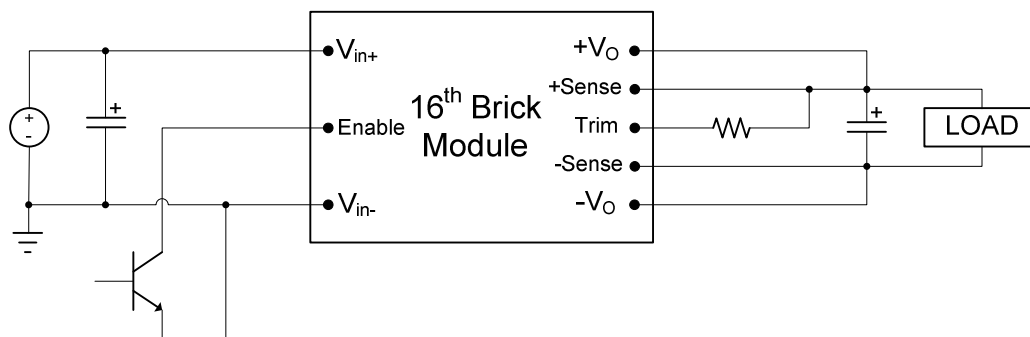

ELECTRICAL SPECIFICATIONS

36–75Vin, 2.5V/20Aout

Conditions: $T_A = 25\text{ }^\circ\text{C}$, Airflow = 300 LFM, $V_{in} = 48\text{ VDC}$, $C_{in} = 33\text{ }\mu\text{F}$, unless otherwise specified.

Input Characteristics					
Parameter	Conditions	Min	Typ	Max	Unit
Operating Input Voltage Range		36	48	75	VDC
Input Under-Voltage Lock-out					
Turn-on Threshold		34.2	35.0	35.9	VDC
Turn-off Threshold		32.4	33.2	34.1	
Input Voltage Transient	100ms			100	VDC
Maximum Input Current	$V_{IN} = 36\text{VDC}; I_{out} = 20\text{A}$			1.7	A
Input Standby Current	Converter Disabled		2	5	mA
Input No-Load Current	Converter Enabled		35	50	mA
Short Circuit Input Current	RMS		20		mA
Input Reflected Ripple Current	5Hz to 50MHz See Fig 11 for setup		5	15	mA _{PK-PK}
Input Voltage Ripple Rejection	120Hz		50		dB
Inrush Current	All	-	-	0.1	A ² /s
Output Characteristics					
Parameter	Conditions	Min	Typ	Max	Unit
Output Voltage Set point	Sense pins connected to output pins	2.462	2.5	2.538	VDC
Output Current		0		20	A
Output Current Limit Inception		21	25	32	A
Peak Short-Circuit Current	10mΩ Short			35	A
RMS Short-Circuit Current	10mΩ Short			2.5	A _{RMS}
External Load Capacitance ²	+ Full Resistive Load	0		10000	uF
Output Ripple and Noise	20MHz Bandwidth See Fig 12 for setup		40	60	mV _{PK-PK}
Output Regulation			±1	±5	mV
Line:			±1	±5	mV
Load:					V
Overall Output Regulation:	Over line, load & temp.	2.425		2.575	



ELECTRICAL SPECIFICATIONS (continued)

36–75Vin, 2.5V/20Aout

Conditions: $T_A = 25\text{ }^\circ\text{C}$, Airflow = 300 LFM, $V_{in} = 48\text{ VDC}$, $C_{in} = 33\text{ }\mu\text{F}$, unless otherwise specified.

Absolute Maximum Ratings					
Parameter	Conditions	Min	Typ	Max	Unit
Input Voltage	Continuous Operation	0		75	VDC
Operating Ambient Temperature	w/derating	-40		+85	$^\circ\text{C}$
Operating Temperature - T_{ref} (See Thermal Derating section)	Open Frame	-40		+123	$^\circ\text{C}$
	Baseplate Option	-40		+115	$^\circ\text{C}$
Storage Temperature		-55		+125	$^\circ\text{C}$
Feature Characteristics					
Parameter	Conditions	Min	Typ	Max	Unit
Switching Frequency			480		kHz
Output Voltage Trim Range ¹		-20		+10	%
Remote Sense Compensation ¹				+10	%
Output Over-voltage Protection	Non-latching	115	125	140	%
Over-temperature Protection	Avg. PCB temp, non-latching		135		$^\circ\text{C}$
Peak Backdrive Output Current during startup into prebiased output	Sinking current from external voltage source equal to $V_{OUT} - 0.6\text{V}$ and connected to the output via 1Ω resistor. $C_{OUT}=220\mu\text{F}$, Aluminum		-	400	mA
Backdrive Output Current in OFF state	Converter disabled		0	5	mA
Enable to Output Turn-ON Time	$V_{OUT} = 0.9 \cdot V_{OUT_NOM}$		20		ms
Output Enable ON/OFF	Negative Enable	Converter ON	-0.5	0.8	VDC
		Converter OFF	2.4	20	VDC
	Positive Enable	Converter ON	2.4	20	VDC
		Converter OFF	-0.5	0.8	VDC
Enable Pin Current Source/Sink	Converter has internal pull-up of approx. 5V		0.25	1	mA
Output Voltage Overshoot @ Startup			0	2	%Vo
Auto-Restart Period	(OCP, OVP)		100		ms



ELECTRICAL SPECIFICATIONS (continued)

36–75Vin, 2.5V/20Aout

Conditions: Ta = 25 °C, Airflow = 300 LFM, Vin = 48 VDC, Cin = 33 µF, unless otherwise specified.

Efficiency					
Parameter	Conditions	Min	Typ	Max	Unit
Full Load	Vin = 48Vin	88	89		%
50% Load		89	90		%
Dynamic Response					
Parameter	Conditions	Min	Typ	Max	Unit
Load Change 50%-75% or 25% to 50% of Iout Max, di/dt = 0.1A/µs	Co = 1 µF ceramic + 47 µF Ceramic		100	200	mV
Settling Time to 1% of Vout			50		µs
Load Change 50%-100% of Iout Max, di/dt = 1 A/µs	Co = 1 µF ceramic + 470 µF tantalum		100	250	mV
Settling Time to 1% of Vout			100		µs
Isolation Specifications					
Isolation Capacitance			1000		pF
Isolation Resistance		10			MΩ
Isolation Voltage	Input to Output	2250			V _{DC}
	Input to baseplate	1500			V _{DC}
	Output to baseplate	1000			V _{DC}
Reliability					
Per Telcordia SR-332, Issue 2: Method I, Case 3 (Io=80% of Io_max, TA=40°C, airflow = 200 lfm, 90% confidence)	MTFB		3,358,741		Hours
	FITs (failures in 10 ⁹ hours)		298		/10 ⁹ Hours

Notes:

1. Combination of remote sense + trim up not to exceed 10% of V_{o,nom}.
2. Higher capacitive loading capability available upon request – consult factory.



3. CHARACTERISTIC CURVES:

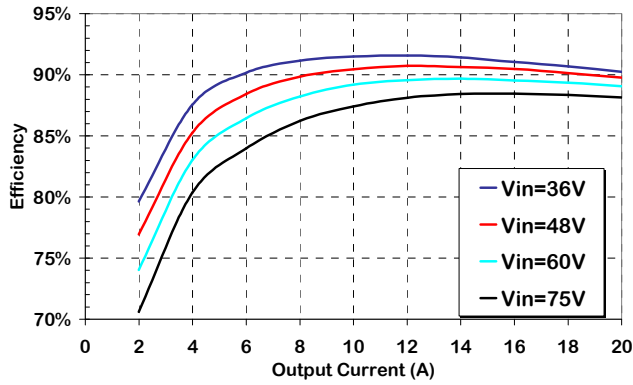

Figure 1. Efficiency vs Output Current, 300lfm airflow, 25°C ambient.

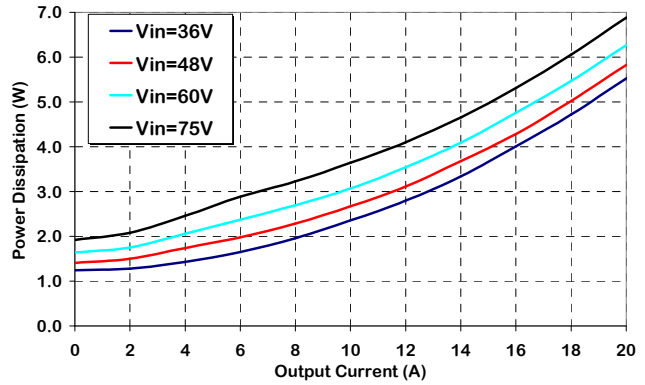

Figure 2. Power Dissipation vs. Load Current, 300lfm airflow, 25°C ambient.

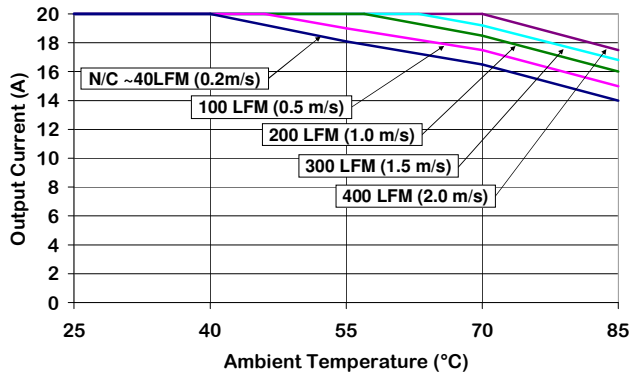

Figure 3. Output Current Derating vs Ambient Temperature & Airflow (converter mounted vertically with air flowing from pin 3 to pin 1, Vin = 48 V.)

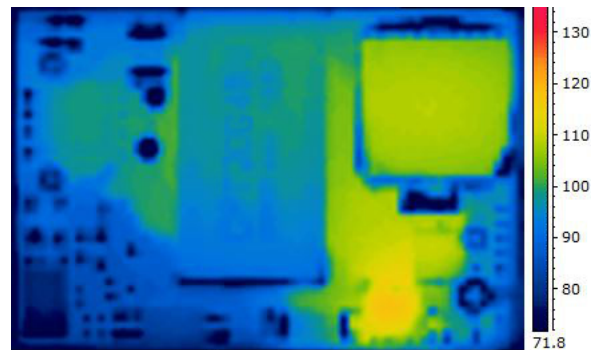

Figure 4. Thermal Image of CPT20G48 20A output, 55C Ambient, 200lfm airflow, Vin = 48V, airflow from pin 3 to pin 1, Tmax = 119°C

CHARACTERISTIC WAVEFORMS:

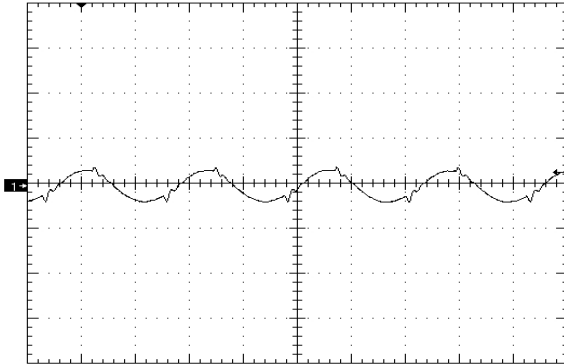

Figure 5. Output Voltage Ripple (50mV/div), time scale – 1uS/div. Vin=Vin_nom, full resistive.

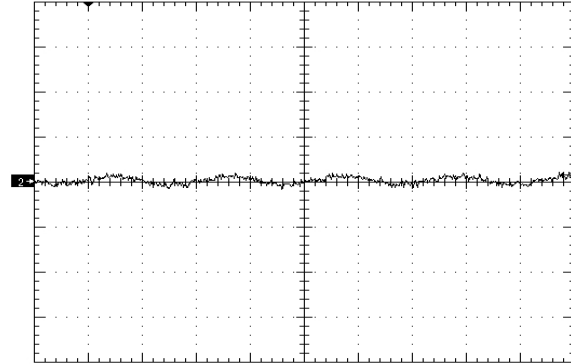

Figure 6. Input Reflected Ripple Current (10mA/div) time scale - 1uS/div. Vin=Vin_nom, full resistive.

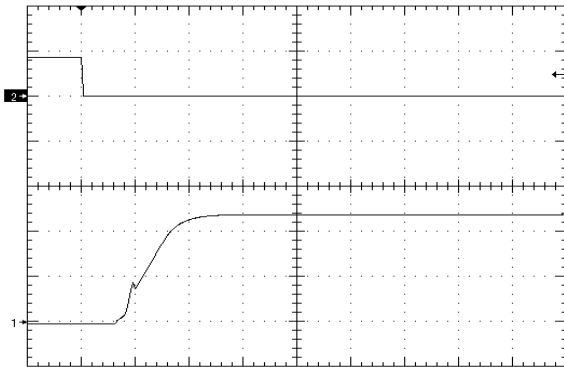

Figure 7. Startup Waveform via Enable Pin, time scale 10mS/div. Vin=Vin_nom, full load Ch1=1V/div, Ch2=5V/div

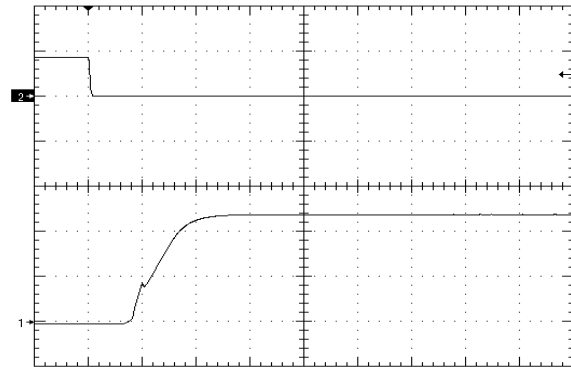

Figure 8. Startup Waveform via Enable Pin, time scale 10mS/div. Vin=Vin_nom, full res. load + 10000uF, negative enbl, Ch1=1V/div, Ch2=5V/div

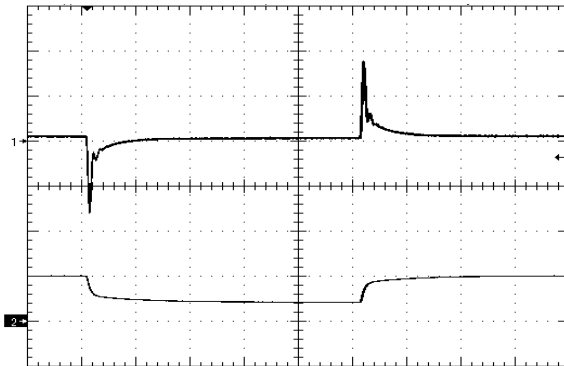

Figure 9. Load Transient Response (50mV/div), di/dt=0.1A/uS, 50% - 25% - 50% of full load, time scale: 200uS/div

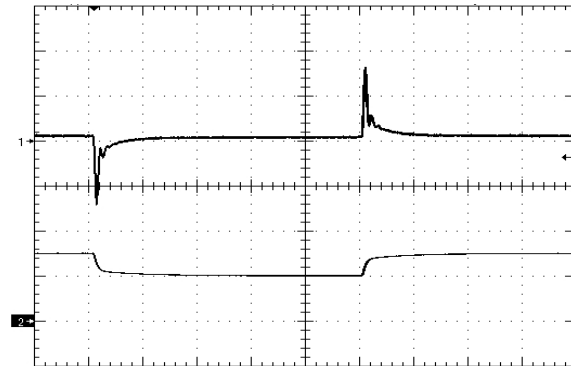
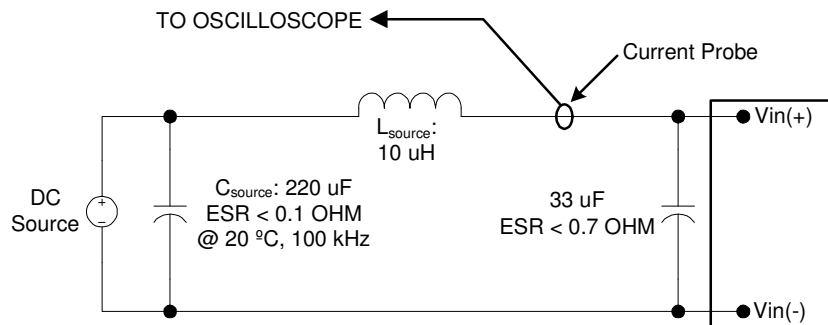

Figure 10. Load Transient Response (50mV/div), di/dt=0.1A/uS, 50% - 75% - 50% of full load, time scale: 200uS/div

Application Notes

Input Voltage Reflected Ripple Measurement

- INPUT REFLECTED RIPPLE TEST SETUP:



Note: Measure input reflected-ripple current with a simulated source inductance (L_{source}) of 10 μH . Capacitor C_s offsets possible source impedance.

Figure 11. Input Reflected-ripple Current Test Setup.

Output Voltage Ripple Measurement

- OUTPUT RIPPLE TEST SETUP:

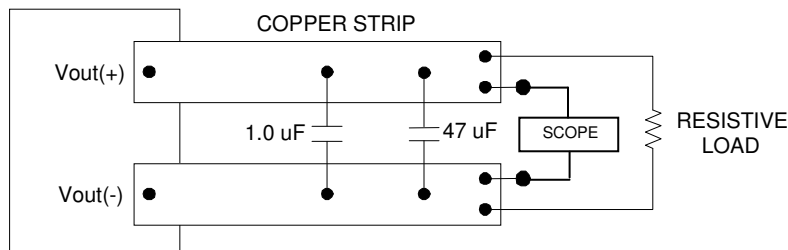

Note: Use a 1 μF X7R ceramic capacitor and 47 μF ceramic capacitor. Scope measurement should be made using a BNC socket. Position the load 3 in. [76mm] from module.

Figure 12. Peak-to-Peak Output Noise Measurement Test Setup.

Application Notes (cont)

Output Voltage Trim

Output voltage adjustment is accomplished by connecting an external resistor between the Trim Pin and either the +Sense or -Sense pins.

- TRIM UP EQUATION:**

$$R_{trim_up} = \left[\frac{5.1 \times V_{o_nom} \times (100 + \Delta\%)}{1.225 \times \Delta\%} - \frac{510}{\Delta\%} - 10.2 \right] \times k\Omega$$

Where R_{trim_up} is the resistance value in k-ohms and $\Delta\%$ is the percent change in the output voltage. E.g. to

trim the output up 10%, $R_{trim_up} = \left[\frac{5.1 \times 12 \times (100 + 10)}{1.225 \times 10} - \frac{510}{10} - 10.2 \right] \times k\Omega$ or $R_{trim_up} = 53.3k\Omega$.

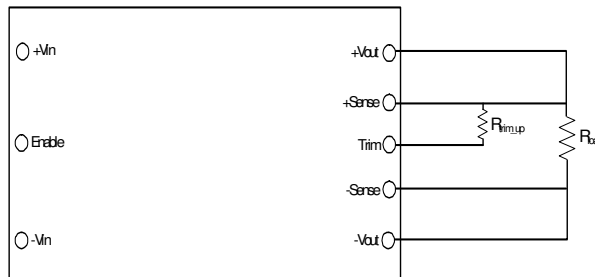

Figure 13. Trim UP circuit configuration

- TRIM-DOWN EQUATION:**

$$R_{trim_down} = \left(\frac{510}{\Delta\%} - 10.2 \right) \times k\Omega$$

Where R_{trim_down} is the resistance value in k ohms and $\Delta\%$ is the percent change in the output voltage.

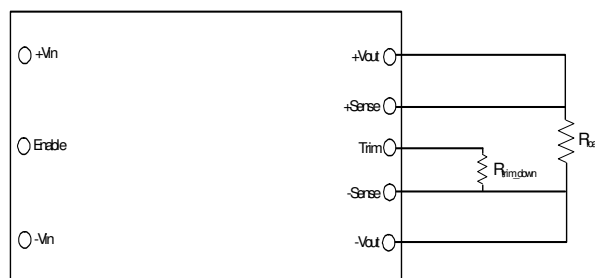
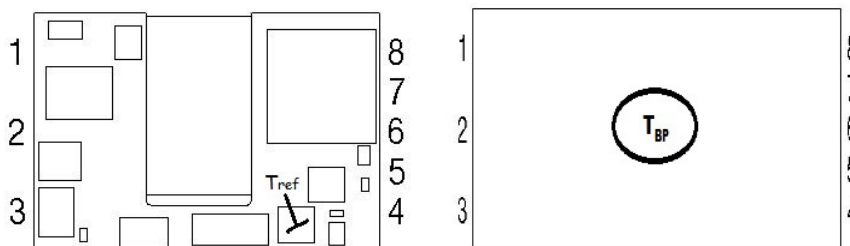

Figure 14. Trim DOWN circuit configuration

Application Notes (cont)

Thermal Derating

- It is preferable that the DC-DC module have an unobstructed flow of air across it for best thermal performance. Components taller than ~ 2mm in front of the module can deflect airflow and possibly create hotspots.
- Significant cooling is achieved through conductive flow from the modules I/O pins to the host PCB. Sufficiently large traces connecting the dc-dc converter to the source and load will help ensure thermal derating performance will meet or exceed the derating curves published in this datasheet. Solder flow-through that contacts standoff of output pins is essential for proper derating performance – especially on models with greater than 10A output current.
- If the module is expected to be operated near the load limits defined in the derating curves, in-system verification of module derating performance should be performed to ensure long-term system reliability. Peak temperatures are to be measured using infrared thermography or by gluing a fine gauge (AWG #40) thermocouple at the T_{ref} location(s) shown below. Temperatures at the specified location(s) are not to exceed 123°C in order to maintain converter reliability. For baseplate models, T_{BP} should not exceed 115°C.



Input Undervoltage Lockout

- The converter is disabled until the input voltage has exceeded the UVLO turn-on threshold. Once the input voltage exceeds this level (see Input Under-Voltage Lock-out in Electrical Specifications table) the module will commence soft-start. Hysteresis of 2-3 volts minimizes the likelihood of pulling the input voltage below the turn-off threshold during startup which could create an undesirable on/off cycling condition. The converter will continue to operate until the input voltage subsequently falls below the UVLO turn-off threshold.

Enable Pin Function

- The module has a remote enable function that allows it to be turned on or off remotely. The Enable pin is referenced to the negative input pin (-Vin) of the converter. Modules can be ordered with either negative or positive enable.
- The negative enable option the module will not turn on unless the enable pin is connected to -Vin. The positive enable option allows the converter to turn on as soon as voltage sufficient to exceed the UVLO of the converter has been applied to the input terminals. In this case the module is turned off by connecting the Enable pin to -Vin. On/off thresholds are located in the Electrical Specifications table.

Application Notes (cont)

Output Overvoltage Protection

- The module has an independent feedback loop that will disable the output of the converter if a voltage greater than about 125% of the nominal set point is detected. When this threshold is reached, the converter will shut down and remain off for the amount of time specified by the Auto-Restart Period. The converter will attempt a restart once this period of time has elapsed.

Output Overtemperature Protection

- To provide protection under certain fault conditions, the unit is equipped with a thermal shutdown circuit. The unit will shutdown if the average PCB temperature exceeds approx. 135°C, but the thermal shutdown is not intended as a guarantee that the unit will survive temperatures beyond its rating. The module will automatically restart once it has cooled below the shutdown temperature minus hysteresis (typically 20 deg C.)

SMT Version Layout Considerations (if applicable)

- Copper traces with sufficient cross-section must be provided for all output & input pins. SMT pads tied to internal power/ground planes must have multiple vias around each SMT pad to couple expected current loads from module pins into internal traces/planes. One 0.024" (0.6mm) diameter via for each 4A of expected source or load current must be provided as close to the termination as possible, preferably in the direction of current flow from SMT pad to load. Vias must be at least 0.024" (0.6 mm) away from the SMT pad to prevent solder from flowing into the vias.
- SMT pads on the host card are to be 0.080" (2.03 mm) diameter. Solder paste screen opening should be 0.075" (1.9 mm) diameter and the screen should be 0.006" (0.15 mm) thick (other thicknesses are possible; 0.006" provides a good compromise between solder volume and coplanarity compensation.)

Paralleling Converters

- Modules may be paralleled but it is recommended that the total power draw not exceed the output power rating of a single module. External sharing controllers are recommended for reliability and to ensure equal distribution of the load to the converters. In lower current applications, ORing diodes can be used to prevent converter interactions and improve current sharing.



Application Notes (cont)

EMC Compliance

To meet Class B compliance for EN55032 (CISPR 32) or FCC part 15 sub part j, the following input filter is required:

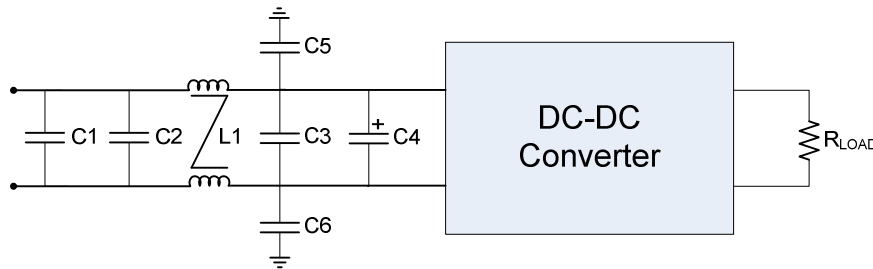

Figure 15. EMI Filter

L1 =	1.32 mH Common Mode Inductor (Pulse P0420)
C1, C2, C3 =	2.2uF ceramic
C4 =	100uF electrolytic
C5, C6 =	10nF (@2kV if output is ref. to earth gnd.)

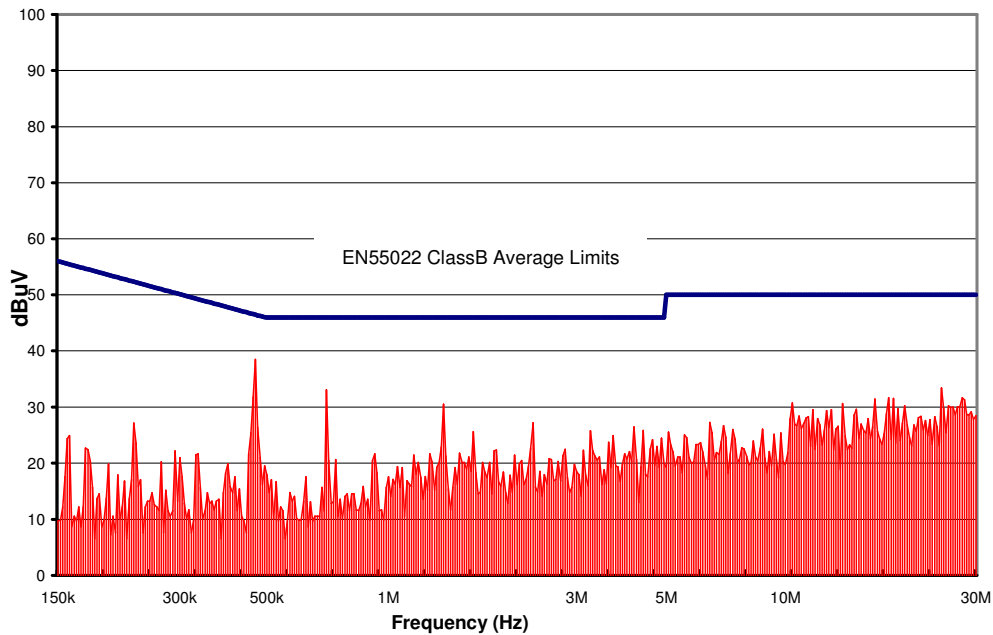
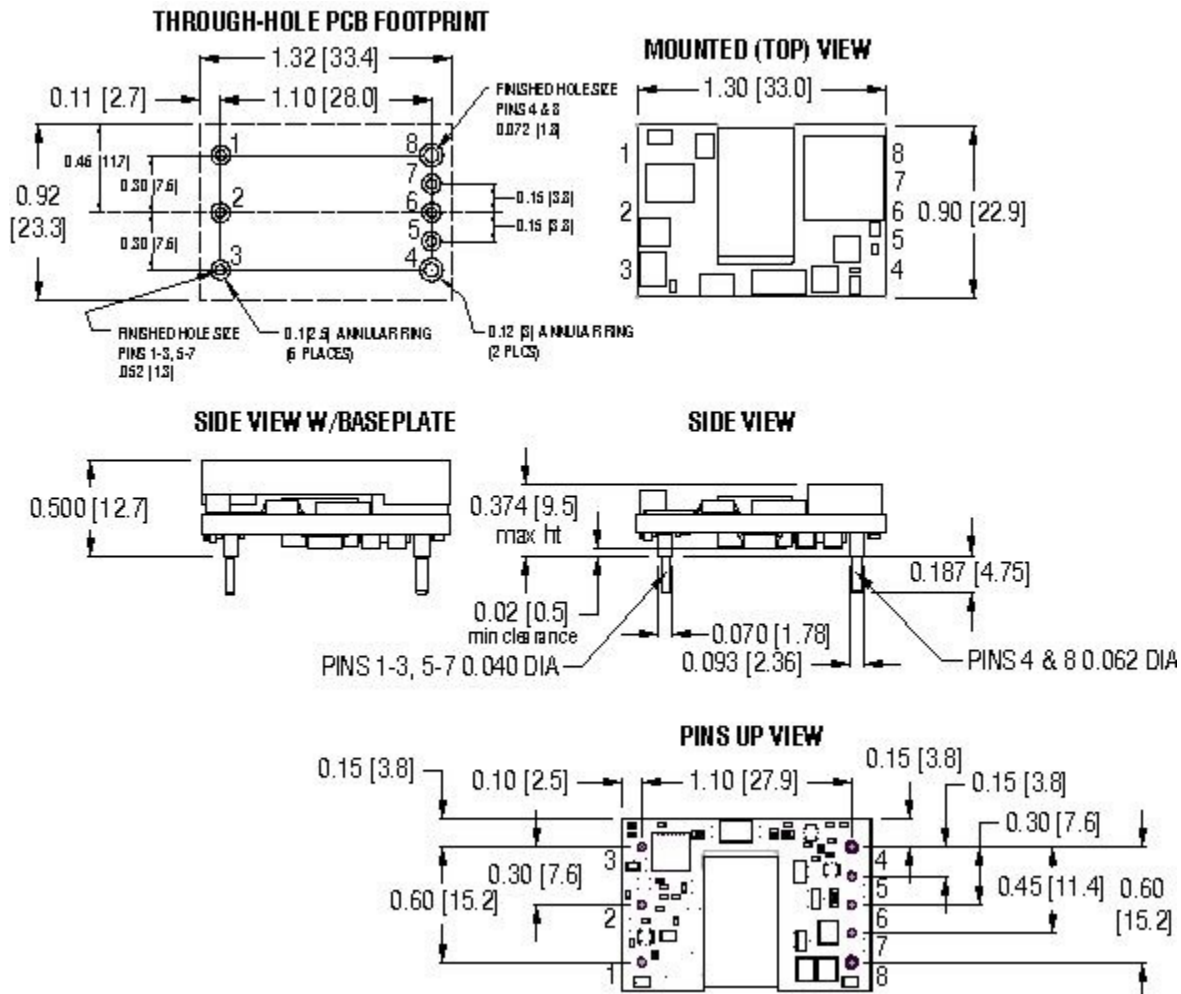

Figure 16. CPT20G48 Conducted Emissions using above specified input filter, Vin = 48V, Full Resistive Load

MODULE PIN ASSIGNMENT:

PIN #	DESIGNATION	NOTES
1	V _{IN} (+)	1) All dimensions in inches [mm] Tolerances: .xx ± 0.02 [.x ± .5] .xxx ± 0.010 [.xx ± .25] 2) Input, on/off control and sense/trim pins are Ø 0.040" [1.02] ± 0.002" [0.05] with Ø 0.070" [1.77] standoff shoulders. 3) Output pins 4 & 8 are Ø 0.062" [1.57] ± 0.003" [0.08] with Ø 0.093" [2.36] standoff shoulders 4) All pins are gold plated with nickel under plating. 5) Weight: 12.5 g (0.44 oz) open frame, 20.5g (0.72 oz) baseplated 6) Workmanship: Meet or exceeds IPC-A-610 Class II
2	On/Off	
3	V _{IN} (-)	
4	V _{OUT} (-)	
5	Sense (-)	
6	Trim	
7	Sense (+)	
8	V _{OUT} (+)	

MECHANICAL OUTLINE – THROUGH-HOLE:



MECHANICAL OUTLINE – SURFACE MOUNT:

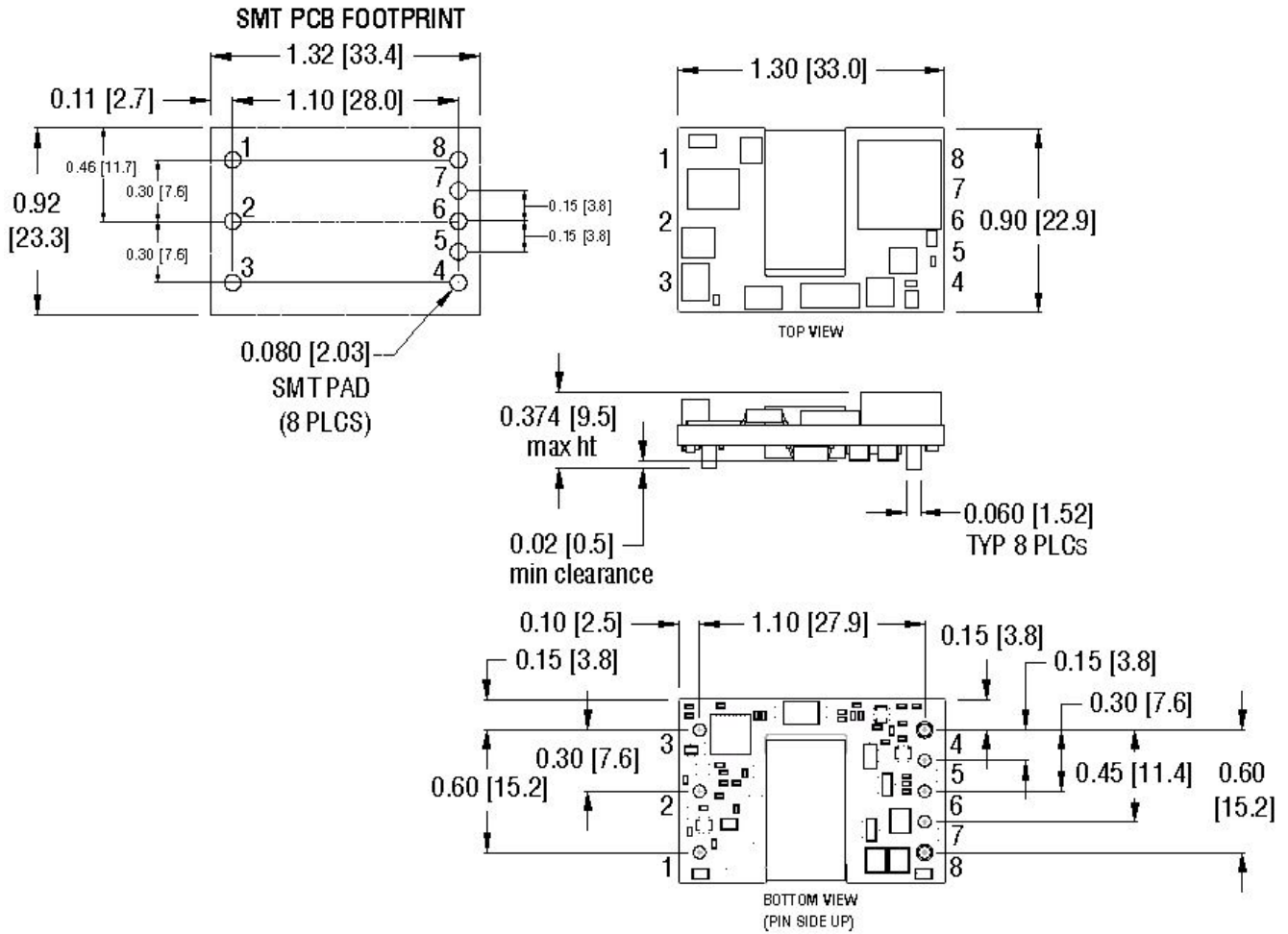

ORDERING INFORMATION:					
Product Identifier	Output Current	Output Voltage	Input Voltage	Enable logic option	Additional features
CPT	20	G	48	N or P	S or B
“Cool Power Technologies”	20A	2.5V	36 – 75V	N = Negative P = Positive	S = Surface Mount B = Baseplate Option

Rev 1.2, 16-February-19

