

Item description

Distribution connector *WINSTA*® MIDI with protection against mismatching

For power and signal transmission: The *WINSTA*® MIDI distribution connector with protection type IP20. On PCBs, in control cabinets or for connecting lights – pluggable installation connectors from WAGO allow you to establish connections according to various requirements in seconds. The coding options reduce installation errors, allowing fast, secure wiring of all components. The pluggable installation connector is protected in accordance with protection type IP20 (When mated: IP2xC (These compact connectors are not designed for use in open, easily accessible areas!)). That results in the fact that users' fingers will never come into contact with energised contact elements. Pluggable installation connectors with B coding from the *WINSTA*® MIDI line are available in gray, light green, or pink, allowing you to distinguish different circuits, for example for light, pumps or, sun blinds. Your own pole marking is possible as well. Important parameters in the selection of a pluggable installation connector are the rated current and voltage: They provide information about possible domains of use and applications. This product has a current rating of 25 A – so it is suitable for robust loads. Our *WINSTA*® MIDI product line offers maximum flexibility for the installation. With its Push-in CAGE CLAMP® spring pressure connection technology, it ensures time-saving, error-free installation and offers customization and flexibility for meeting an enormous variety of installation requirements.

Subject to changes. Please also observe the further product documentation!



Push-in CAGE CLAMP® spring pressure connection technology – pluggable installation instead of laborious screw connections!

WINSTA® is the pluggable connection system that is ideally tailored to the strict requirements of electrical installation. It offers error-free installation of cables and components, quickly and reliably. Now you can also lower installation expenses without compromising safety and quality: The WINSTA® MIDI pluggable installation connector with locking lever eliminates the need for servicing and prevents unnecessary downtime.

- effective protection against mismatching
- simple circuits
- with B coding for controllers, for example sun blinds and lighting fixtures
- custom-engineered solutions
- quick replacement of defective units during ongoing operation

Data

Notes

Variants:

Other pole markings

Other versions (or variants) can be requested from WAGO Sales or configured at <https://configurator.wago.com/>.

Electrical data

Ratings per IEC/EN

Ratings per	IEC/EN 60664-1
Nominal voltage (III/3)	250 V
Rated impulse voltage (III/3)	4 kV
Rated current	25 A
Legend (ratings)	(III / 3) ≙ Overvoltage category III / Pollution degree 3

Ratings per UL 1977

Note for the US market	Some versions may also be used for current interruption in accordance with the UL certificate in select applications with currents below 16 A and voltages up to 600 V. For further information, please contact your local sales office.
Rated voltage (UL 1977)	600 V
Rated current UL 1977	23 A

Subject to changes. Please also observe the further product documentation!

WAGO GmbH & Co. KG
 Hansastr. 27
 32423 Minden
 Phone: +49571 887-0 | Fax: +49571 887-169
 Email: info.de@wago.com | Web: www.wago.com

Do you have any questions about our products?
 We are always happy to take your call at +49 (571) 887-44222.



General

Note on contact resistance	approx. 1 mΩ of contact resistance approx. 0.25 mΩ contact transition plug/socket
----------------------------	--------------------------------------------------------------------------------------

Connection data

Total number of potentials	3
----------------------------	---

Connection 1

Pole number	3
-------------	---

Physical data

Pin spacing	10 mm / 0.394 inches
Width	30 mm / 1.181 inches
Height	32.7 mm / 1.287 inches
Depth	46 mm / 1.811 inches

Mechanical Data

Application	Control technology
Coding	B
Marking	1 2 3
Potential marking	1 2 3
Mating force of a plug-in connection	approx. 20 ... 70 N (depending on pole number)
Retention force of a plug-in connection	When locked: > 80 N
Unmating force of a plug-in connection	Unlocked: approx. 20 ... 70 N (depending on pole number)
Number of mating cycles	200, without resistive load
Type of distribution box	Distribution connector, 3-way
Protection type	IP20; When mated: IP2xC (These compact connectors are not designed for use in open, easily accessible areas!)

Plug-in connection

Contact type (pluggable connector)	Socket/plug
Mismating protection	Yes
Note on mismating protection	All <i>WINSTA</i> [®] components are 100% protected against mismating when: a.) plugging different numbers of poles b.) plugging while rotated 180

Subject to changes. Please also observe the further product documentation!



	c.) plugging while laterally staggered d.) plugging one pole
Locking lever	yes
Locking of plug-in connection	locking lever
Note on locking system	All connectors for mounted installations (snap-in versions for lighting fixtures or devices, all types of PCB and distribution connectors) are factory-equipped with locking levers to ensure plugs and sockets are securely locked. Additional locking levers are only required for flying leads (plug/socket).
Number of locking levers	4

Material Data

Note (material data)	Information on material specifications can be found here
Color	gray
Insulation material	Polyamide (PA66)
Flammability class per UL94	V0
Contact material	Copper or copper alloy; surface-treated
Contact plating	Tin
Fire load	0.487 MJ
Weight	25.5 g

Environmental requirements

Processing temperature	-5 ... +40 °C
Continuous operating temperature	-35 ... +85 °C
Note on continuous operating temperature	Insulating parts for temperatures \leq 105 °C

Commercial data

Product Group	20 (Winsta)
eCl@ss 10.0	27-44-06-03
eCl@ss 9.0	27-44-06-03
ETIM 8.0	EC002567
ETIM 7.0	EC002567
PU (SPU)	50 pcs
Packaging type	box
Country of origin	DE
GTIN	4050821687658

Subject to changes. Please also observe the further product documentation!

WAGO GmbH & Co. KG
 Hansastr. 27
 32423 Minden
 Phone: +49571 887-0 | Fax: +49571 887-169
 Email: info.de@wago.com | Web: www.wago.com

Do you have any questions about our products?
 We are always happy to take your call at +49 (571) 887-44222.

Customs tariff number

85366990990

Environmental Product Compliance

RoHS Compliance Status





Compliant, No Exemption

Approvals / Certificates

General approvals

Logo	Approval	Additional Approval Text	Certificate name
	cURus Underwriters Laboratories Inc.	UL 1977	E45171

Counterpart

	Item no. 770-243 Socket; 3-pole; Cod. B; 4,00 mm ² ; gray	www.wago.com/770-243
	Item no. 770-253 Plug; 3-pole; Cod. B; 4,00 mm ² ; gray	www.wago.com/770-253
	Item no. 771-9993/205-103 pre-assembled connecting cable; Eca; Plug/open-ended; 3-pole; Cod. B; H05VV-F 3 x 1.0 mm ² ; 1 m; 1,00 mm ² ; gray	www.wago.com/771-9993/205-103
	Item no. 771-9993/005-103 pre-assembled interconnecting cable; Eca; Socket/plug; 3-pole; Cod. B; H05VV-F 3 x 1.0 mm ² ; 1 m; 1,00 mm ² ; gray	www.wago.com/771-9993/005-103
	Item no. 771-9993/105-103 pre-assembled connecting cable; Eca; Socket/open-ended; 3-pole; Cod. B; H05VV-F 3 x 1.0 mm ² ; 1 m; 1,00 mm ² ; gray	www.wago.com/771-9993/105-103

Optional accessories

Cover

Cover

	Item no.: 770-360 Lockout cap; for plugs; 5-pole; separable; yellow	www.wago.com/770-360
	Item no.: 770-201 Lockout cap; 12-pole, separable; for sockets; Plastic; black	www.wago.com/770-201

Subject to changes. Please also observe the further product documentation!

WAGO GmbH & Co. KG

Hansastr. 27

32423 Minden

Phone: +49571 887-0 | Fax: +49571 887-169

Email: info.de@wago.com | Web: www.wago.com

Do you have any questions about our products?

We are always happy to take your call at +49 (571) 887-44222.

Item no.: 770-221

Lockout cap; 12-pole, separable; for sockets; Plastic; white

www.wago.com/770-221

Mounting

Mounting accessories



Item no.: 770-623

Mounting plate; 3-pole; for distribution connectors; Plastic; black

www.wago.com/770-623



Item no.: 770-673

Mounting plate; 3-pole; for distribution connectors; Plastic; white

www.wago.com/770-673

Downloads

Documentation

Bid Text

770-1714 X81 - Datei	2019 Feb 19	xml 2.8 kB	Download
770-1714 doc - Datei	2015 Mar 12	doc 23.0 kB	Download

CAD/CAE-Data

CAE data

WSCAD Universe 770-1714	URL	Download
ZUKEN Portal 770-1714	URL	Download

CAD data

2D/3D Models 770-1714	URL	Download
-----------------------	-----	----------

Environmental Product Compliance

Compliance Search

Environmental Product Compliance 770-1714	URL	Download
-------------------------------------------	-----	----------

Subject to changes. Please also observe the further product documentation!

3-way distribution connector; 3-pole; Cod. B; 1 input; 3 outputs; gray

Installation Notes

Installation

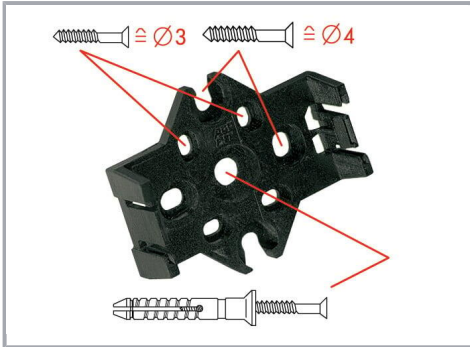

Mounting plates can be secured using commercially available screws or nail-drive anchors.



The distribution connectors snap together when attached to the mounting plate.



To release the distribution connector, unlock the latch using a screwdriver.

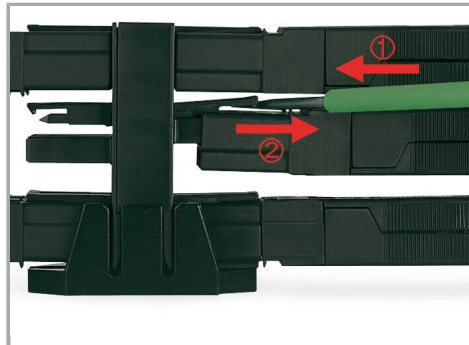

All distribution connector connections are locked and protected against accidental disconnection directly after mating. Locking of any connection is released using a screwdriver, even if all connections are used.

Product family

WINSTA® MIDI

[Show all products from the family](#)

Subject to changes. Please also observe the further product documentation!